



WISDOM  
PLAYGROUNDS

VOLUME 30

www.wisdomplaygrounds.com



WISDOM PLAYGROUNDS

3879 US HWY 421, Wilmington, NC 28401  
www.wisdomplaygrounds.com  
910-769-3576

# OUTDOOR PLAYGROUND EQUIPMENT

PROMOTING CHILDREN'S PHYSICAL AND INTELLECTUAL DEVELOPMENT THROUGH ACTIVITY!





007

## WisePlay Quick Ship

- WisePLAY Quick Ship
- WisePLAY Inclusive Quick Ship
- WiseTOT Quick Ship
- WiseNEX Quick Ship
- WiseFREE Quick Ship
- WiseSITE Quick Ship

095

## WiseTOT

- WiseTOT Lean on Me Series
- WiseTOT Custom
- WiseTOT Retro Play & GO

113

## WisePLAY

- WisePLAY Inclusive
- WisePLAY Custom
- WisePLAY Theme

165

## WiseMAX

- WiseMAX Inclusive
- WiseMAX Theme

# ABOUT US

At Wisdom Playgrounds, our business philosophy is simple. We promote children's physical and intellectual development through activity while continuously being dedicated to creating high quality, safe, durable, and environmentally friendly places for communities to come together and explore a healthy lifestyle full of activity.

WISDOM continues to focus on providing unique designs and innovative concepts with a wide variety of Quick Ship options. What sets WISDOM apart in the Quick Ship industry for playground equipment? Our ability to warehouse by component means we can produce our WisePLAY 3.5" Quick Ship pre-design modular structures in 3-5 days. This allows our customers the ability, not only to pick from one of our 75 pre-designed units, but also semi-custom design their own from our large array of stock offering all at a reasonable price. We offer the fastest delivery option you can find in the industry for commercial playground equipment.

We are proud to be one of the first in the industry to offer a fully Inclusive playground system with two different Quick Ship options. Our WisePLAY 3.5" system allows for us to keep our warehouses fully stocked with entire inventory product lines, so we are ready to ship and deliver to you in 3-5 days. With a modern warehousing & logistics center in Wilmington, North Carolina, we are ready to provide top-notch services and out of this world fast delivery.



WisePLAY QUICK SHIP	WiseTOT QUICK SHIP	WiseNEX QUICK SHIP	INCLUSIVE QUICK SHIP	WiseFREE QUICK SHIP	WiseSITE QUICK SHIP
WiseTOT	WisePLAY	WiseMAX	WiseFIT	WiseWORX	NatureWISE
Standard	Inclusive	TreeHouse	Castle	Pirate Ship	
3.5" Post	5.0" Post	Climbers	Slides	ADA	Capacity 26-30
					Activities





**3-5 DAYS**

## Quick Ship

Great solution for tight time lines when your playground needs to provide a variety of activities in small or medium space.



### WiseFIT

WiseCIRCUIT  
WiseXR

179

### WiseWORX

WiseNEX  
WiseQUBES  
WiseROCK  
WiseSPHERE  
WiseFREE

183

### NatureWISE

NatureCHALLENGE  
NaturePLAY Theme  
NatureMAX Theme

201

### INDEX

221



# WHAT MAKES WISDOM DIFFERENT

## ADVANTAGE COMPARISON

### COMPETITOR VS WISDOM



**SET EQUIPMENT SHIPMENT**  
CAN NOT MEET CUSTOMIZED DESIGN

VS



**MODULAR DESIGN**

MODULAR DESIGN, UNIQUE SHAPE FOR EASY IDENTIFICATION  
CLEAR STRUCTURE FOR EASY ASSEMBLY, EFFICIENT AND  
CONVENIENT CONSTRUCTION.

### COMPETITOR VS WISDOM

15-30  
DAYS

VS

3-5 DAYS

**SLOWER SHIPPING**

SET EQUIPMENT IN STOCK  
WILL HAVE TROUBLE TO SHIP IF  
THERE ARE MISSING PARTS

**SHIPS IN 3-5 DAYS**

WISDOM IS DIFFERENT FROM THE OVERALL  
MARKET IN THE AVAILABILITY WE  
OFFER. WE STOCK A WIDE VARIETY OF  
EQUIPMENT IN OUR QUICK SHIP SECTION.  
FROM THE TIME THE ORDER IS PLACES  
DELIVERY OF PRODUCT WILL ARRIVE IN 3-5  
DAYS

### COMPETITOR VS WISDOM

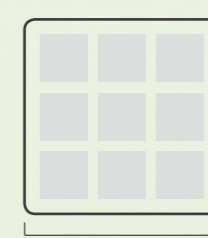

37"

**SMALL DECK**

DECK SIZE 37 X 37 IN, COVERING 9.4  
SQ FT. CAPACITY FOR ONLY 9 KIDS  
PER DECK, MAX LOADING WEIGHT  
2500LBS ONLY

VS

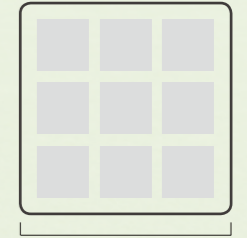

41"

**BIG DECK**

DECK SIZE 41 X 41 IN, COVERING 11.6 SQ  
FT. **23%** MORE THAN 37 X 37 IN DECK.  
INCREASE CAPACITY TO 11 KIDS PER  
DECK, MAX LOADING WEIGHT 3000LBS

**3.5 INCH SYSTEM FULLY INCLUSIVE**



### COMPETITOR VS WISDOM

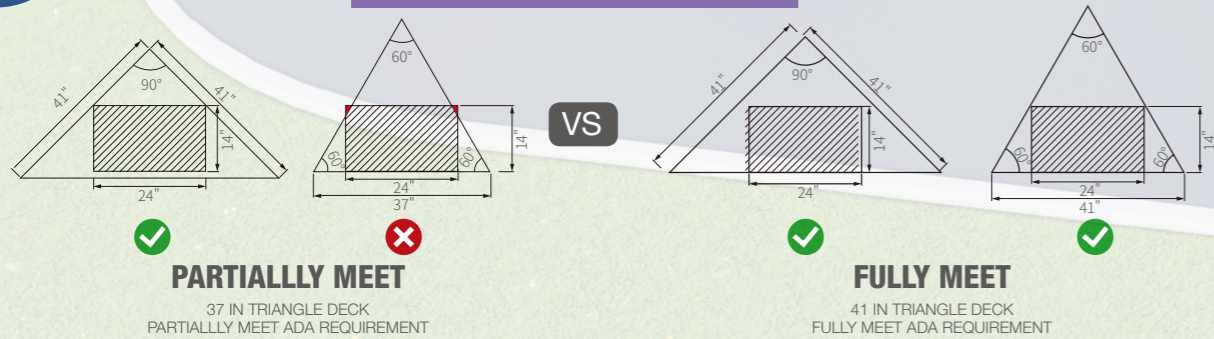

### COMPETITOR VS WISDOM



**LOW QUALITY MATERIAL**

LOW COST MATERIAL, SIMPLE PRODUCTION PROCESS  
OBVIOUS GAPS, LESS ABILITY TO RESIST OUTDOOR ENVIRONMENT

VS

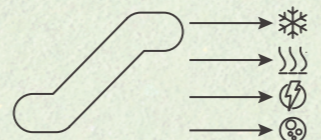

**FINE MATERIAL AND PRODUCTION**

SLIDES WITH ROTATIONAL MOLDING PROCESS, GRANULATION  
TECHNOLOGY AND MODIFIED MATERIALS  
HEAT AND COLD RESISTANCE, ANTI-AGING AND ANTISTATIC

### COMPETITOR VS WISDOM

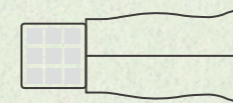

X

DECK SIZE 37 X 37 IN  
CAN NOT USE DOUBLE SLIDE

VS



✓

DECK SIZE 41 X 41 IN  
FULLY MEET THE WIDTH  
REQUIREMENT FOR DOUBLE SLIDE



### COMPETITOR VS WISDOM

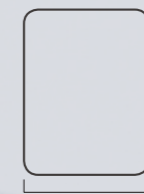

31"

REGULAR SIZE PANEL  
THIN AND LIGHT, LESS SPACIOUS  
DESIGN

VS

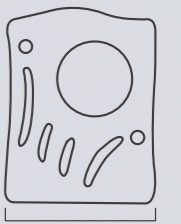

34"

PANEL IS 3 IN WIDER  
COVERING AREA **10%** MORE  
GREAT APPEARANCE.



In line with international safety standards



## LEADER IN HEALTH & SAFETY

Here at Wisdom Playgrounds, we strive to have high standards and safe products for all to use. We understand children are still developing their bodies and are susceptible to harmful substances, and dangerous chemicals. We strictly monitor the content standards of chemicals that are used in our playground equipment. We know that children thrive when they are naturally active, and in a safe environment. Which is why Wisdom Playgrounds makes our products safe, stable, and to the highest standards possible. Our structures are suited to take on high traffic areas like kindergartens and daycares. We also take into consideration the necessity to develop our products in ways that will reduce collision damage and prevent potential dangers to both the physical and mental health of children who engage with our products.

Children are the hope and the future of our nation. It is our responsibility to let children grow up healthy, safe, and in a green learning environment. This will stay the core value of Wisdom Playgrounds for many more years to come.



## SUSTAINABLE & ENVIRONMENTAL PROTECTOR

WISDOM has successively obtained multiple certificates that comply with international standards, such as ISO9001, ISO14001, ISO45001, FSC, IPEMA and China Green Product certification, marking WISDOM's strategic ability and determination to adhere to sustainable development!

Implement the concept of eco and quality, integrate global advanced education concepts into the DNA of WISDOM products with the eyes of the world, and aspire to provide green, eco, and high-quality products for children around the world. Help children explore the world with peace of mind and experience a beautiful and happy childhood!

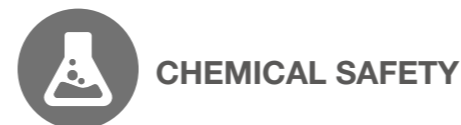



# THE MAKING OF A WISDOM PLAYGROUND SYSTEMS

Quality you can see, value you can measure



## LIFE-TIME WARRANTY

- 1: Excellent quality: All equipment materials are specially selected, sturdy, safe, eco, and durable.
- 2: Long-term warranty: Up to 15-100 years warranty on main structure against structural failure due to material or manufacturing defects.

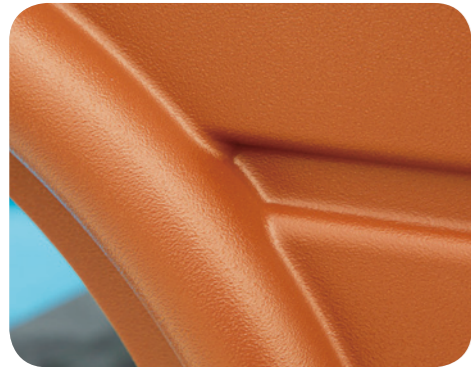

## ROTOMOLDED PROCESS

- 1: Quality materials: Selected high-grade LLDPE raw materials, linear low density polyethylene, impact resistance, cracking resistance, heat/cold resistance, acid, alkali and organic solvent resistance, etc., perfectly adapted to various harsh outdoor environments.
- 2: Flexible design: not limited by size/pattern/color/thickness, designers can freely play and easily meet ideal expectations.
- 3: Eco & Safety: one-time molding, no scraps, no waste, non-toxic and odorless.



## CLAMP ASSEMBLY

- 1: Clamp design: abandon the common phenomenon of only screw fixing, which is prone to loosening and shaking over time. The clamp design is stable and firm.
- 2: High quality metal: strong stability, burst resistance, cracking resistance, rusty resistance and fine polished, no corners or sharp edges, ensure safety in daily use.
- 3: Convenient assembly: "One loop, one clamp" closed-loop fastening. Simple assembly, convenient maintenance.



## PROFESSIONAL WELDING

- 1: Mature craftsmanship: Senior craftsman meticulously works, with even welding joints and careful polishing, with no burrs, incomplete penetration, or porosity overall.
- 2: Safety first: The welding joints are stable, firm, and smooth, strictly ensuring product safety.



## TUBULAR POST

- 1: Thickening material: fabricated of 3.5 in. outside diameter, 13 gauge galvanized steel tubing, making it more secure and safe.
- 2: Two mount types: Inground mount and surface mount as needed.

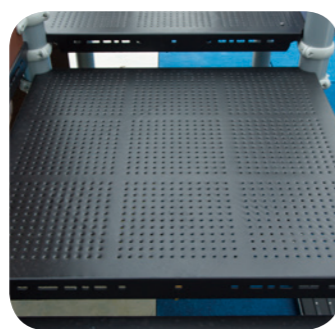

## DECK/STAIRS

- 1: Selected Metal: High strength cold rolled steel flat, structurally and mechanically stable, corrosion-resistant, weather resistant, safe and eco, suitable for outdoor use.
- 2: PVC coating: After professional technical treatment such as gluing, preheating, PVC coating, and high-temperature curing, the steel deck has improved its anti slip, anti wear, anti static, and anti crack properties, making it new over time.



## QUALITY POWDER COATING

- 1: High-end technology: To avoid problems such as rust and aging of steel tubes, we use high-end hot dip galvanizing technology combined with high-quality outdoor powder coating to extend the service life!
- 2: Craftsmanship process: Galvanized tubes require a total of 13 processes, including water washing, oil removal/impurity removal, and electrostatic spraying. Ensure smooth and flat surface, rust and corrosion resistance, and long-term durability.





# Quick Ship

WISDOM PLAYGROUNDS offers a wide variety of Quick Ship options to make any project a little faster, without jeopardizing the quality of the product to do so. When ordering a Quick Ship item, the standard delivery time is 3-5 days from the time the order is placed.

Wisdom Playgrounds is an industry leader in providing a quick solution to delivering playgrounds fast and efficiently. We understand that there is a need for playgrounds to be offered at a reasonable cost in order to be a part of the greater solution to keeping children and adults active and living a healthy lifestyle full of activity. We are proud to offer equipment that is environmentally safe, along with high quality and durability.

- 009 WisePLAY Quick Ship
- 055 WisePLAY Inclusive Quick Ship
- 059 WiseTOT Quick Ship
- 077 WiseNEX Quick Ship
- 083 WiseFREE Quick Ship
- 093 WiseSITE Quick Ship



[www.wisdomplaygrounds.com](http://www.wisdomplaygrounds.com)



# WisePLAY Quick Ship

WisePLAY Quick Ship playgrounds are a great solution for anyone that needs to enhance their facility with quality play space and needs to do so quickly. As the name suggests, QuickShip playgrounds can be on-site in a very short time frame. Quick Ship playgrounds provide a variety of activities in a small or medium-sized space. With the weight and size of these structures being smaller, it keeps the cost of purchasing the structure down, as well as the overall shipping costs.

WisePLAY structures are built with 3.5" posts instead of 5" posts, which allows the structure to be lighter, and more versatile. Every playground in the Quick Ship section has the options of either a Primary color palette, or a Nature color palette. Without sacrificing features such as safety or durability, we accommodate getting you a high quality playgrounds packed full of activities in a QUICK AND TIMELY manner.



Quick Ship



WisePLAY



3.5" Post



ADA



## SHININ BRIGHT | QSWP-350002

Ages: 2-12

Fall Height: 48"

Use Zone: 35'x28'

Equipment Size: 22'10" x 15'3"

Timbers: 28

NATURE



PRIMARY



3.5



26-30

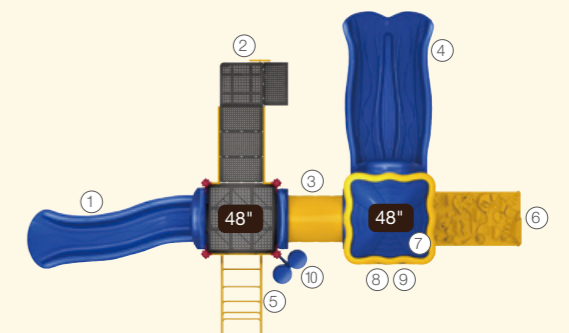

- ① 4ft Single Slide
- ③ 31" Crawl Tunnel
- ⑤ 4ft Arch Climber
- ⑦ Pyramid Roof
- ⑨ Safety Panel

- ② ADA 4ft Transfer Station
- ④ 4ft Double Slide
- ⑥ 4ft/5ft Rock Climber
- ⑧ Saddle Seat (Below)
- ⑩ Bongo



W/O Roof 00



Pyramid Roof 11



Leaf Roof 12



Shade Roof 13





## MONKEY PLAY | QSWP-350001

Ages: 2-12  
Fall Height: 48"  
Use Zone: 26'x24'  
Equipment Size: 13'11"x11'8"  
Timbers: 23

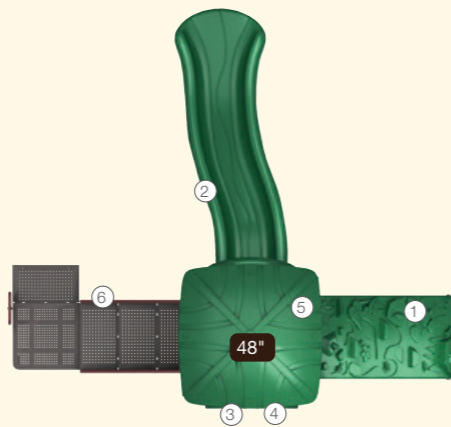

- ① 4ft/5ft Rock Climber
- ② 4ft Single Slide
- ③ Gears Panel
- ④ Saddle Seat (Below)
- ⑤ Square Leaf Roof
- ⑥ ADA 4ft Transfer Station



## CHARLESTON | QSWP-350012

Ages: 2-12  
Fall Height: 48"  
Use Zone: 29'x28'  
Equipment Size: 17'2"x15'6"  
Timbers: 23

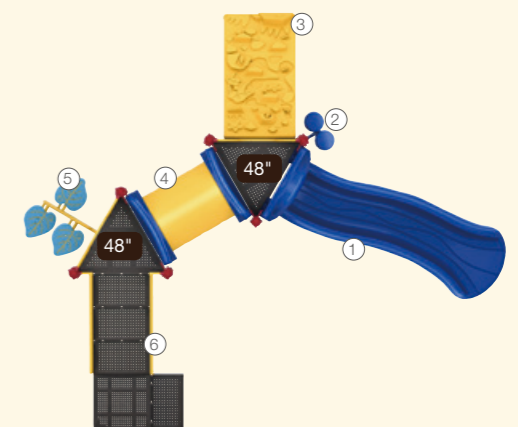

- ① 4ft Single Slide
- ② Bongo
- ③ 4ft/5ft Rock Climber
- ④ 31" Crawl Tunnel
- ⑤ 4ft Leaf Step Climber
- ⑥ 4ft ADA Stairs



W/O Roof 00



Pyramid Roof 11



Leaf Roof 12



Shade Roof 13



W/O Roof 00



Pine Topper 07



Palm Topper 06





## NORTHERN PLACE | QSWP-350016

Ages: 2-12  
 Fall Height: 48"  
 Use Zone: 26'x35'  
 Equipment Size: 13'11"x22'3"  
 Timbers: 23

**NATURE**      **PRIMARY**

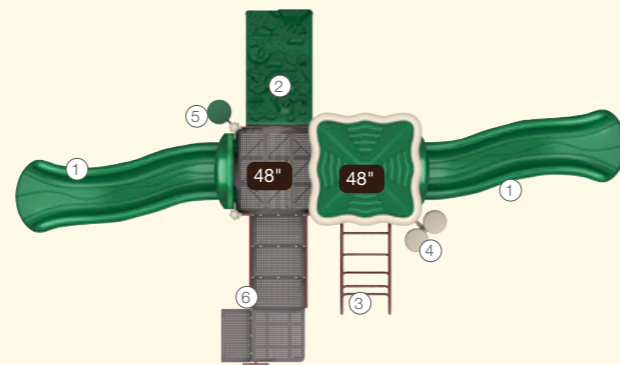
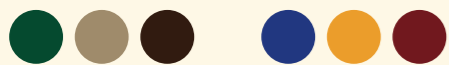

- ① 4ft Single Slide
- ② 4ft/5ft Rock Climber
- ③ 4ft Arch Climber
- ④ Bongo
- ⑤ PE Stool
- ⑥ 4ft ADA Stairs



W/O Roof 00



Pyramid Roof 11



Leaf Roof 12



Shade Roof 13



## AUGUSTA | QSWP-350009

Ages: 2-12  
 Fall Height: 48"  
 Use Zone: 39'x29'  
 Equipment Size: 26'2"x17'9"  
 Timbers: 28

**NATURE**      **PRIMARY**

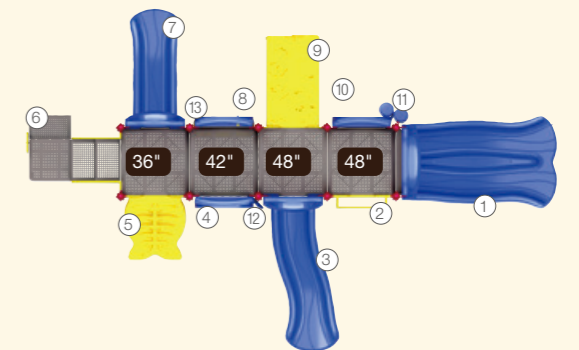

- ① 4ft Double Slide
- ② 3ft Upright Vertical Climber
- ③ 4ft Single Slide
- ④ Four In A Row Panel
- ⑤ 2ft/3ft Fish Climber
- ⑥ 3ft ADA Stairs
- ⑦ 3ft Single Slide
- ⑧ Gears Panel
- ⑨ 4ft/5ft Rock Climber
- ⑩ World Map Panel
- ⑪ Bongo
- ⑫ Rain Wheel
- ⑬ Saddle Seat



W/O Roof 00



Pyramid Roof 11



Leaf Roof 12



Shade Roof 13





## BUGALOO | QSWP-350008

Ages: 2-12  
Fall Height: 48"  
Use Zone: 30'x30'  
Equipment Size: 17'10"x17'1"  
Timbers: 31

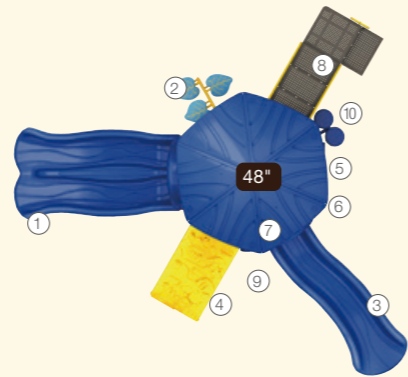

- ① 4ft Double Slide
- ② 4ft Leaf Step Climber
- ③ 4ft Single Slide
- ④ 4ft/5ft Rock Climber
- ⑤ Gears Insert
- ⑥ Saddle Seat (Below)
- ⑦ Hex Leaf Roof
- ⑧ ADA 4ft Transfer Station
- ⑨ Rain Wheel
- ⑩ Bongo

**NATURE**      **PRIMARY**

● ● ●      ● ● ●



W/O Roof 00



Leaf Roof 32



Shade Roof 33



## SADIE CREEK | QSWP-350028

Ages: 2-12  
Fall Height: 60"  
Use Zone: 33'x31'  
Equipment Size: 19'4"x18'8"  
Timbers: 27

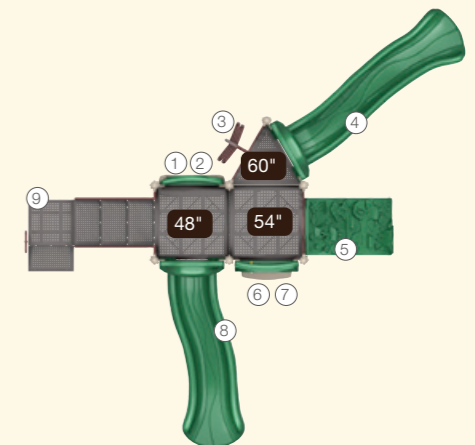

- ① Beads & Cups Panel
- ② Saddle Seat (Below)
- ③ 5ft Wing Climber
- ④ 4ft/5ft Rock Climber
- ⑤ 4ft Single Slide
- ⑥ Gears Panel
- ⑦ Counter Panel (Below)
- ⑧ ADA 3ft Transfer Station
- ⑨ ADA 4ft Transfer Station

**NATURE**      **PRIMARY**

● ● ●      ● ● ●



W/O Roof 00



Pyramid Roof 11



Leaf Roof 12



Shade Roof 13





**NEW**



### SPEED RACER | QSWP-350025

Ages: 2-12  
Fall Height: 48"  
Use Zone: 27'x34'  
Equipment Size: 21'10"x15'8"  
Timbers: 28

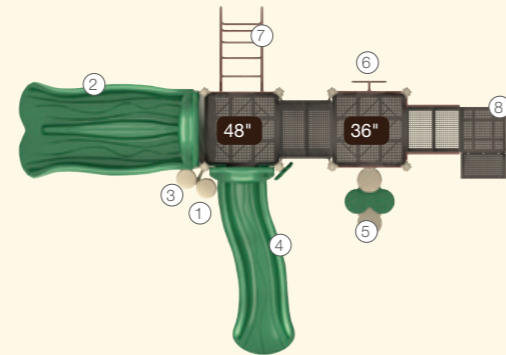

- ① Saddle Seat
- ② 4ft Double Slide
- ③ Bongo
- ④ 4ft Single Slide
- ⑤ 3ft Trunk Climber
- ⑥ 3ft Snake Climber
- ⑦ 4ft Arch Climber
- ⑧ ADA Transfer Station

**NATURE**      **PRIMARY**

● ● ●      ● ● ●



### PALM SPRINGS | QSWP-350059

Ages: 2-12  
Fall Height: 60"  
Use Zone: 26' x 24'  
Equipment Size: 21'2"x16'1"  
Timbers: 26

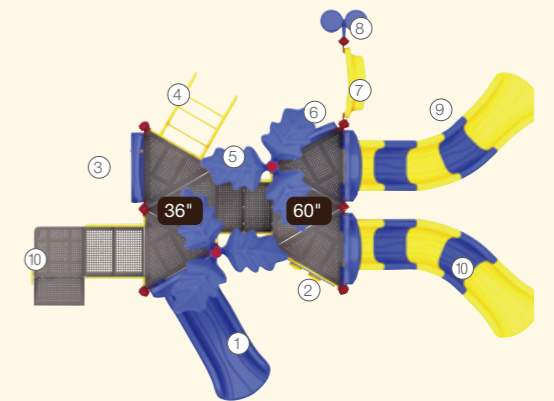

- ① 3ft Single Slide
- ② 5ft Vertical Climber
- ③ Gears Panel
- ④ 3ft Arch Climber
- ⑤ Palm Topper
- ⑥ Beads & Cups Panel
- ⑦ Counter Panel
- ⑧ Bongo
- ⑨ 5ft Sectional Slide 45°Left Turn
- ⑩ 5ft Sectional Slide 45°Right Turn
- ⑪ ADA Transfer Station

**NATURE**      **PRIMARY**

● ● ●      ● ● ●



W/O Roof 00



Pyramid Roof 11



Leaf Roof 12



Shade Roof 13



W/O Roof 00



Palm Topper 06



Pine Topper 07





**NEW**



## ROCKY | QSWP-350046

Ages: 2-12  
Fall Height: 60"  
Use Zone: 34' x 31'  
Equipment Size: 21'4"x18'11"  
Timbers: 26

**NATURE**      **PRIMARY**  
● ● ●      ● ● ●

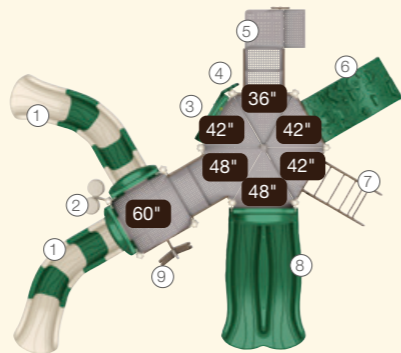

- ① 5ft Sectional Slide 45°Left Turn
- ② Bongo
- ③ Gears Panel
- ④ Rain Wheel
- ⑤ ADA 3ft Transfer Station
- ⑥ 4ft/5ft Rock Climber
- ⑦ 4ft Arch Climber
- ⑧ 4ft Double Slide
- ⑨ 4ft Straight Rung Climber



W/O Roof 00



Leaf Roof 32



Shade Roof 33

**NEW**



## JANIE | QSWP-350045

Ages: 2-12  
Fall Height: 60"  
Use Zone: 33' x 34'  
Equipment Size: 20'10"x21'7"  
Timbers: 27

**NATURE**      **PRIMARY**  
● ● ●      ● ● ●

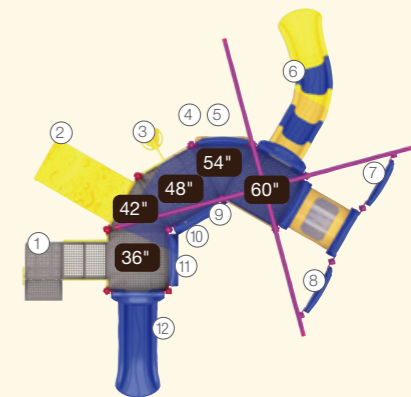

- ① ADA 3ft Transfer Station
- ② 4ft/5ft Rock Climber
- ③ 4ft Pod Climber
- ④ Maze Panel
- ⑤ Saddle Seat
- ⑥ 5ft Sectional Slide 45°Left Turn
- ⑦ Puzzle Insert
- ⑧ Beads & Cups Insert
- ⑨ Rain Wheel
- ⑩ Gears Panel
- ⑪ World Map Panel
- ⑫ 3ft Single Slide



W/O Roof 00



Pyramid Roof 11



Leaf Roof 12



Shade Roof 13





## AHOY MATE | QSWP-350021

Ages: 2-12  
Fall Height: 48"  
Use Zone: 34'x29'  
Equipment Size: 27'4"x16'13"  
Timbers: 25

**NATURE**      **PRIMARY**

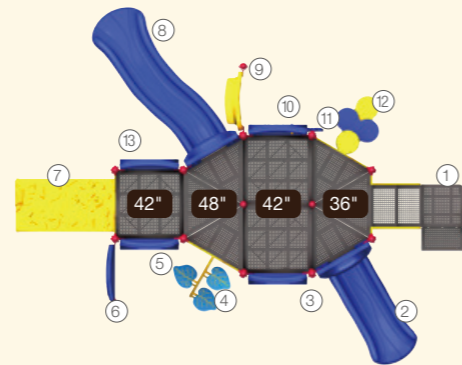
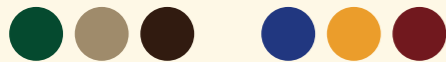

- ① ADA Transfer Station
- ③ World Map Panel
- ⑤ Four In A Row Panel
- ⑥ Puzzle Panel
- ⑦ 4ft/5ft Rock Climber
- ⑨ Counter Panel
- ⑩ Gears Panel
- ⑪ Rain Wheel
- ⑬ Bubble Panel
- ② 3ft Single Slide
- ④ 4ft Leaf Climber
- ⑧ 4ft Single Slide
- ⑫ 3ft Trunk Climber



W/O Roof 00



Pyramid Roof 11



Leaf Roof 12



Shade Roof 13



## CAROUSEL | QSWP-350020

Ages: 5-12  
Fall Height: 72"  
Use Zone: 30'x34'  
Equipment Size: 17'7"x21'4"  
Timbers: 29

**NATURE**      **PRIMARY**

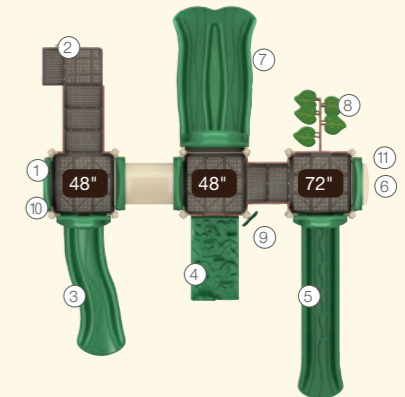

- ① Maze Panel
- ③ 4ft Single Slide
- ⑤ 6ft Sectional Slide
- ⑦ 4ft Double Slide
- ⑨ Rain Wheel
- ⑩ Counter Panel (Below)
- ② ADA 3ft Transfer Station
- ④ 4ft PE Rock Climber
- ⑥ World Map Panel
- ⑧ 6ft Leaf Step Climber
- ⑪ Saddle Seat (Below)



W/O Roof 00



Pyramid Roof 11



Leaf Roof 12



Shade Roof 13





## SHADY PINES | QSWP-350005

Ages: 5-12  
 Fall Height: 60"  
 Use Zone: 41'x30'  
 Equipment Size: 28'6"x17'3"  
 Timbers: 29

**NATURE**      **PRIMARY**

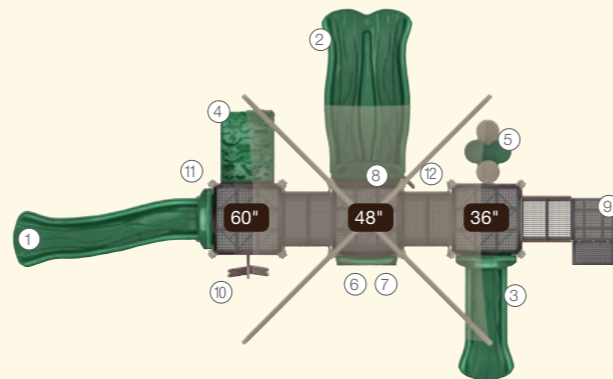
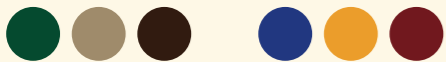

- ① 5ft Single Slide
- ② 4ft Double Slide
- ③ 3ft Single Slide
- ④ 4ft/5ft Rock Climber
- ⑤ 3ft Trunk Climber
- ⑥ World Map Panel
- ⑦ Saddle Seat (Below)
- ⑧ 14ft x 14ft Square Shade
- ⑨ ADA 3ft Transfer Station
- ⑩ 5ft Wing Climber
- ⑪ Counter Panel
- ⑫ Rain Wheel



W/O Roof 00



Pyramid Roof 11



Leaf Roof 12



Shade Roof 13



## OLYMPIA | QSWP-350023

Ages: 5-12  
 Fall Height: 60"  
 Use Zone: 32'x50'  
 Equipment Size: 37'11"x19'8"  
 Timbers: 34

**NATURE**      **PRIMARY**

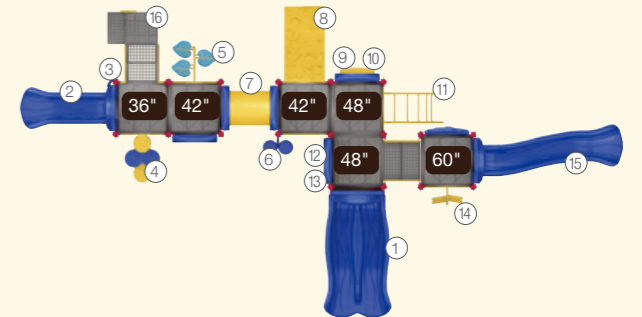

- ① 4ft Double Slide
- ② 3ft Single Slide
- ③ Rain Wheel
- ④ 3ft Trunk Climber
- ⑤ 4ft Leaf Step Climber
- ⑥ Bongo
- ⑦ 31" Crawl Tunnel
- ⑧ 4ft/5ft Rock Climber
- ⑨ ABC Panel
- ⑩ Counter Panel (Below)
- ⑪ 4ft Arch Climber
- ⑫ World Map Panel
- ⑬ Saddle Seat (Below)
- ⑭ 5ft Wing Climber
- ⑮ 5ft Single Slide
- ⑯ ADA 3ft Transfer Station



W/O Roof 00



Pyramid Roof 11



Leaf Roof 12



Shade Roof 13





## HARPERS PLACE | QSWP-350019

Ages: 5-12  
 Fall Height: 72"  
 Use Zone: 29'x47'  
 Equipment Size: 34'10"x17'1"  
 Timbers: 32

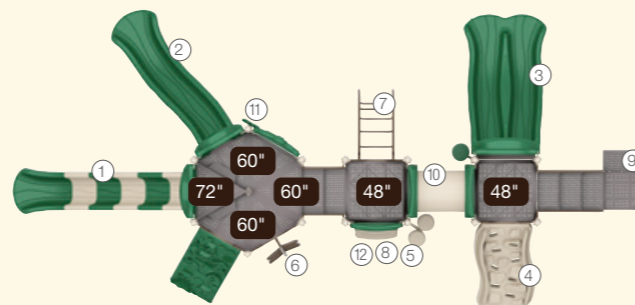

- ① 6ft Sectional Slides
- ② 5ft Single Slide
- ③ 4ft Double Slide
- ④ 4ft/5ft Rock Climber
- ⑤ Bongo
- ⑥ 5ft Wing Climber
- ⑦ 4ft Arch Climber
- ⑧ Counter Panel(Below)
- ⑨ ADA Transfer Station
- ⑩ 31" Crawl Tunnel
- ⑪ Rain Wheel
- ⑫ Maze Panel(Above)

**NATURE**      **PRIMARY**

● ● ●      ● ● ●



## TIMBER TRACKS | QSWP-350006

Ages: 5-12  
 Fall Height: 60"  
 Use Zone: 30'x34'  
 Equipment Size: 22'10"x15'3"  
 Timbers: 28

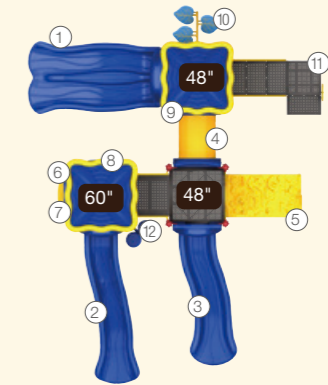

- ① 4ft Double Slide
- ② 5ft Single Slide
- ③ 4ft Single Slide
- ④ 31" Crawl Tunnel
- ⑤ 4ft/5ft Rock Climber
- ⑥ Gears Panel
- ⑦ Counter Panel (Below)
- ⑧ Safety Panel
- ⑨ Saddle Seat (Below)
- ⑩ 4ft Leaf Step Climber
- ⑪ ADA 4ft Transfer Station
- ⑫ Bongo

**NATURE**      **PRIMARY**

● ● ●      ● ● ●







## LEAFY TIME | QSWP-350003

Ages: 5-12  
 Fall Height: 84"  
 Use Zone: 31'x31'  
 Equipment Size: 18'6"x19'  
 Timbers: 28

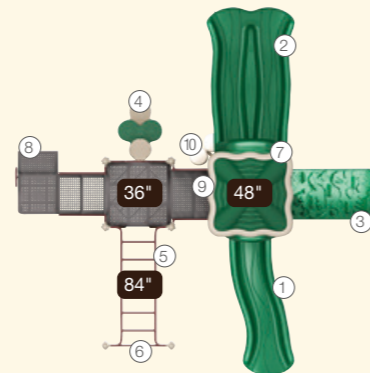

- ① 4ft Single Slide
- ② 4ft Double Slide
- ③ 4ft/5ft Rock Climber
- ④ 3ft Trunk Climber
- ⑤ Challenge Ladder
- ⑥ Overhead Entry Ladder
- ⑦ Pyramid Roof
- ⑧ ADA 3ft Transfer Station
- ⑨ 12" Rise Inter Stairs
- ⑩ Bongo

**NATURE**      **PRIMARY**

● ● ●      ● ● ●

3.5



W/O Roof 00



Pyramid Roof 11



Leaf Roof 12



Shade Roof 13



## ALL POINTS | QSWP-350015

Ages: 5-12  
 Fall Height: 84"  
 Use Zone: 34'x28'  
 Equipment Size: 21'6"x16'  
 Timbers: 28

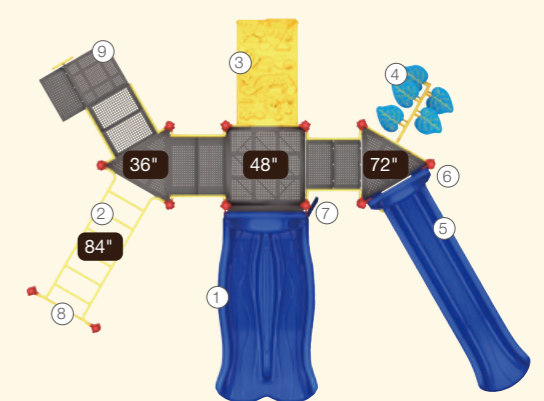

- ① 4ft Double Slide
- ② Challenge Ladder
- ③ 4ft/5ft Rock Climber
- ④ 6ft Leaf Step Climber
- ⑤ 6ft Single Slide
- ⑥ Counter Panel
- ⑦ Rain Wheel
- ⑧ Overhead Entry Ladder
- ⑨ ADA 3ft Transfer Station

**NATURE**      **PRIMARY**

● ● ●      ● ● ●

3.5



W/O Roof 00



Pyramid Roof 11



Leaf Roof 12



Shade Roof 13





## JUNGLE PLAY | QSWP-350026

Ages: 5-12  
 Fall Height: 84"  
 Use Zone: 29'x31'  
 Equipment Size: 19'x16'11"  
 Timbers: 25

**NATURE**      **PRIMARY**

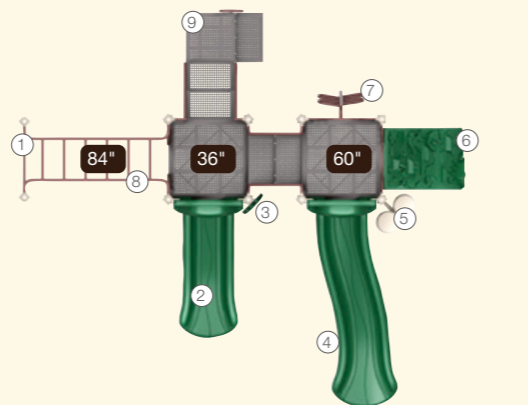

- ① Overhead Entry Ladder
- ③ Rain Wheel
- ⑤ Bongo
- ⑦ 5ft Wing Climber
- ⑨ ADA 3ft Transfer Station
- ② 3ft Single Slide
- ④ 5ft Single Slide
- ⑥ 4ft/5ft Rock Climber
- ⑧ Challenge Ladder



## MIGHTY MAGIC | QSWP-350027

Ages: 5-12  
 Fall Height: 84"  
 Use Zone: 33'x32'  
 Equipment Size: 20'10"x19'3"  
 Timbers: 29

**NATURE**      **PRIMARY**

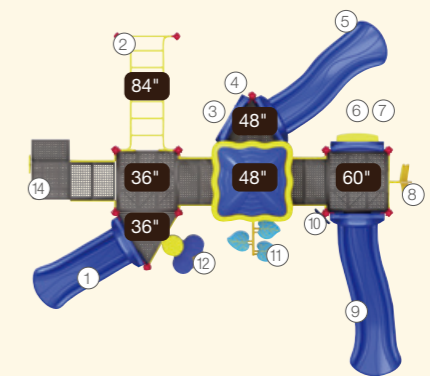

- ① 3ft Single Slide
- ③ Gears Panel
- ⑤ 4ft Single Slide
- ⑦ Counter Panel (Below)
- ⑨ 5ft Single Slide
- ⑪ 4ft Leaf Step Climber
- ⑬ Overhead Entry Ladder
- ② Challenge Ladder
- ④ Saddle Seat (Below)
- ⑥ Window Panel
- ⑧ 5ft Wing Climber
- ⑩ Rain Wheel
- ⑫ 3ft Trunk Climber
- ⑭ ADA 3ft Transfer Station



W/O Roof 00



Pyramid Roof 11



Leaf Roof 12



Shade Roof 13



W/O Roof 00



Pyramid Roof 11



Leaf Roof 12



Shade Roof 13





## DENVER | QSWP-350022

Ages: 5-12  
Fall Height: 60"  
Use Zone: 40'x28'  
Equipment Size: 27'4"x16'  
Timbers: 27

**NATURE**      **PRIMARY**

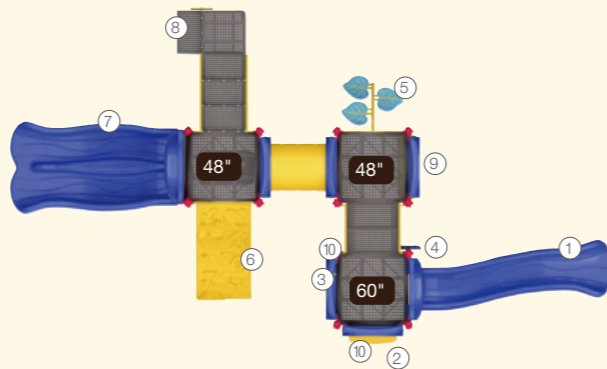
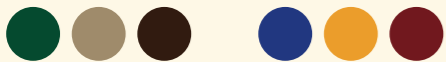

- ① 5ft Single Slide
- ② Four In A Row Panel
- ③ Gears Panel
- ④ Rain Wheel
- ⑤ 4ft Leaf Step Climber
- ⑥ 3ft PE Rock Climber
- ⑦ 4ft Double Slide
- ⑧ ADA Transfer Station
- ⑨ Saddle Seat
- ⑩ Counter Panel



W/O Roof 00



Pyramid Roof 11



Leaf Roof 12



Shade Roof 13



## FALCON RIDGE | QSWP-350014

Ages: 5-12  
Fall Height: 72"  
Use Zone: 48'x29'  
Equipment Size: 35'3"x16'8"  
Timbers: 32

**NATURE**      **PRIMARY**

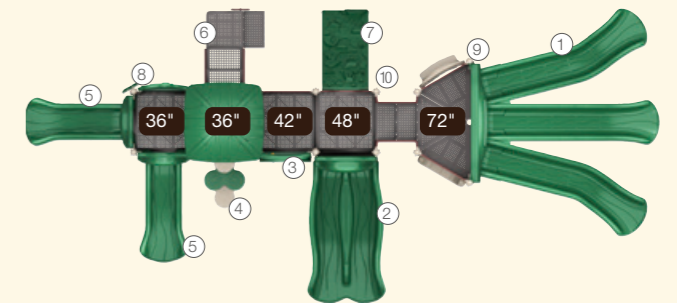

- ① 6ft Triple Slide
- ② 4ft Double Slide
- ③ Gears Panel
- ④ 3ft Trunk Climber
- ⑤ 3ft Single Slide
- ⑥ 3ft ADA Stairs
- ⑦ 4ft/5ft Rock Climber
- ⑧ Rain Wheel
- ⑨ Saddle Seat
- ⑩ Counter Panel



W/O Roof 00



Pyramid Roof 11



Leaf Roof 12



Shade Roof 13





**NEW**

I AM REVERSIBLE



## DAVIS GRAY | QSWP-350044

Ages: 5-12  
Fall Height: 48"  
Use Zone: 29' x 28'  
Equipment Size: 16'5" x 16'  
Timbers: 24

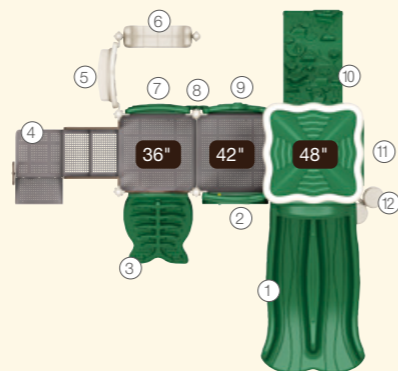

- ① 4ft Double Slide
- ② Gears Panel
- ③ 3ft Fish Climber
- ④ ADA 3ft Transfer Station
- ⑤ Maze Panel
- ⑥ Saddle Seat
- ⑦ Counter Panel
- ⑧ Rain Wheel
- ⑨ Safety Panel
- ⑩ 4ft/5ft Rock Climber
- ⑪ Clear Panel
- ⑫ Bongo



W/O Roof 00



Pyramid Roof 11



Leaf Roof 12



Shade Roof 13



## MOUNT RAINIER | QSWP-350018

Ages: 5-12  
Fall Height: 60"  
Use Zone: 35' x 32'  
Equipment Size: 22'6" x 19'9"  
Timbers: 27

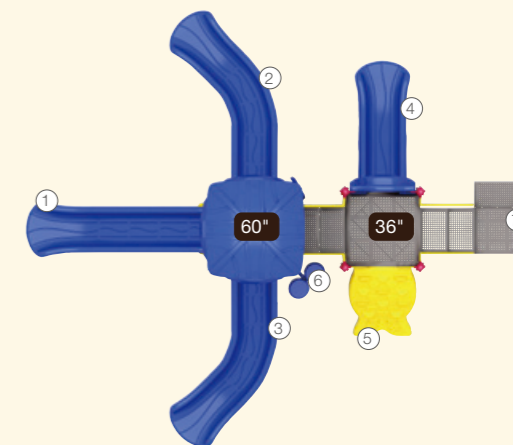

- ① 5ft Single Slide
- ② 5ft Single Slide Right Turn
- ③ 5ft Single Slide Left Turn
- ④ 3ft Single Slide
- ⑤ 2ft/3ft Fish Climber
- ⑥ Bongo
- ⑦ 4ft ADA Stairs



W/O Roof 00



Pyramid Roof 11



Leaf Roof 12



Shade Roof 13





**NEW**



## KENAI | QSWP-350061

Ages: 5-12  
Fall Height: 84"  
Use Zone: 36' x 26'  
Equipment Size: 23'3"x13'9"  
Timbers: 25

**NATURE**      **PRIMARY**

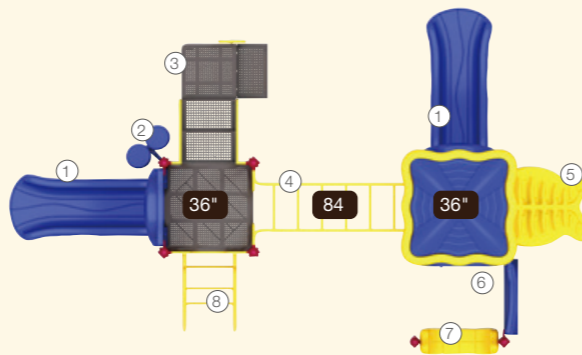
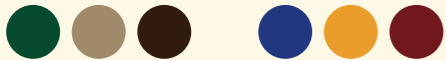

- ① 3ft Single Slide
- ② ADA 3ft Transfer Station
- ③ 2ft/3ft Fish Climber
- ④ Saddle Seat
- ⑤ Bongo
- ⑥ Challenge Ladder
- ⑦ ABC Panel
- ⑧ 3ft Arch Climber



Pine Topper 00



Pyramid Roof 11



Leaf Roof 12



Shade Roof 13



**NEW**



## POETER | QSWP-350062

Ages: 5-12  
Fall Height: 72"  
Use Zone: 36'x29'  
Equipment Size: 23'10"x16'9"  
Timbers: 28

**NATURE**      **PRIMARY**

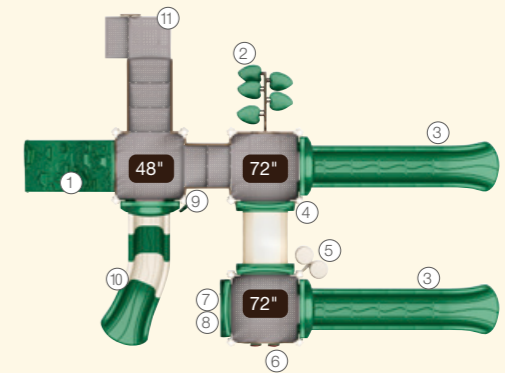

- ① 4ft Rock Climber
- ② 6ft Straight Slide
- ③ Bongo
- ④ Beads & Cups Panel (Above)
- ⑤ Rain Wheel
- ⑥ ADA 3ft Transfer Station
- ⑦ 4ft Leaf Step Climber
- ⑧ Saddle Seat (Below)
- ⑨ 5ft PE Rock Climber
- ⑩ Gears Panel(Below)
- ⑪ 4ft Sectional Slide



W/O Roof 00



Pyramid Roof 11



Leaf Roof 12



Shade Roof 13





**NEW**



## TIMBER RIDGE | QSWP-350063

Ages: 5-12  
Fall Height: 60"  
Use Zone: 37'x35'  
Equipment Size: 24'6"x22'2"  
Timbers: 31

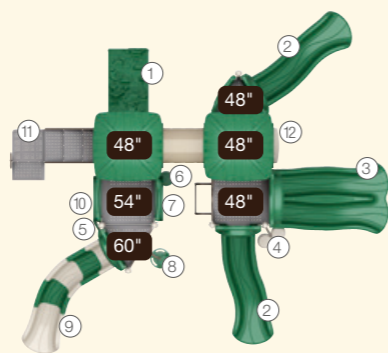

- ① 4ft Rock Climber
- ② 4ft Single Slide
- ③ 4ft Double Slide
- ④ Bongo
- ⑤ Rain Wheel
- ⑥ PE Stool
- ⑦ Four In A Row Panel
- ⑧ 5ft Pod Climber
- ⑨ 4ft Sectional Slide 45° Left Turn
- ⑩ Maze Panel
- ⑪ ADA 4ft Transfer Station

**NATURE**      **PRIMARY**

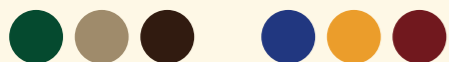

W/O Roof 00



Pyramid Roof 11



Leaf Roof 12



Shade Roof 13



**NEW**



## WILD RUN | QSWP-350064

Ages: 5-12  
Fall Height: 84"  
Use Zone: 51' x 32'  
Equipment Size: 39'x19'1"  
Timbers: 37

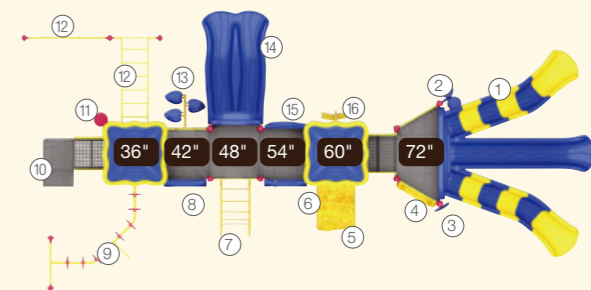

- ① 6ft Triple Sectional Split Slide
- ② Bongo
- ③ Rain Wheel
- ④ Saddle Seat
- ⑤ 4ft/5ft Rock Climber
- ⑥ Gears Panel
- ⑦ 4ft Arch Climber
- ⑧ Clear Panel
- ⑨ 90° Overhead Swinging Rings
- ⑩ ADA 3ft Transfer Station
- ⑪ PE Stool
- ⑫ Net Climber-Ladder
- ⑬ 4ft Leaf Step Climber
- ⑭ 4ft Double Slide
- ⑮ Beads & Cups Panel
- ⑯ 5ft Wing Climber

**NATURE**      **PRIMARY**



W/O Roof 00



Pyramid Roof 11



Leaf Roof 12



Shade Roof 13





**NEW**



## GALENA | QSWP-350065

Ages: 5-12  
Fall Height: 84"  
Use Zone: 51'x38'  
Equipment Size: 39'x25'8"  
Timbers: 38

**NATURE**      **PRIMARY**



W/O Roof 00



Leaf Roof 32



Shade Roof 33



**NEW**



## SKYLER | QSWP-350066

Ages: 5-12  
Fall Height: 84"  
Use Zone: 40' x 42'  
Equipment Size: 27'1"x29'8"  
Timbers: 34

**NATURE**      **PRIMARY**

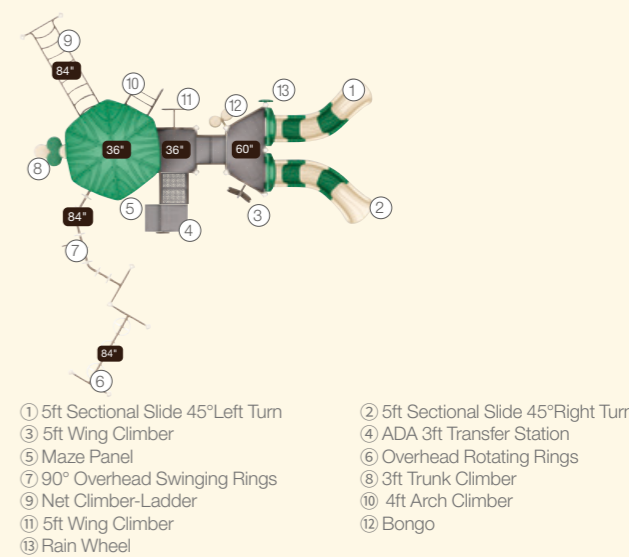

W/O Roof 00



Leaf Roof 32



Shade Roof 33





NEW



## MCKINLEY | QSWP-350067

Ages: 5-12  
Fall Height: 84"  
Use Zone: 35'x33'  
Equipment Size: 32'8"x20'6"  
Timbers: 31

NATURE PRIMARY

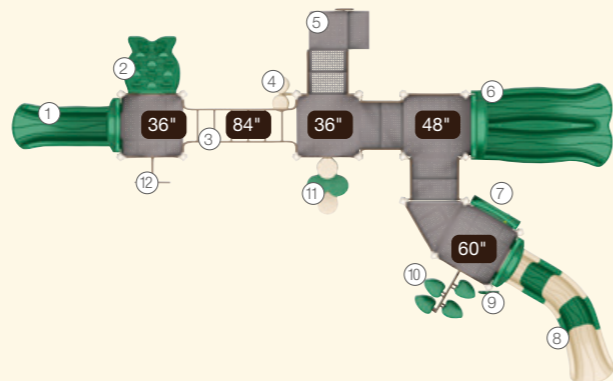
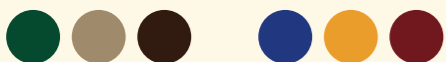

- ① 3ft Single Slide
- ② 3ft Fish Climber
- ③ Net Climber-Ladder
- ④ Bongo
- ⑤ ADA 4ft Transfer Station
- ⑥ 4ft Double Slide
- ⑦ Gears Panel
- ⑧ 5ft Sectional Slide 45° Right Turn
- ⑨ Rain Wheel
- ⑩ 4ft Leaf Step Climber
- ⑪ 3ft Trunk Climber
- ⑫ 3ft Wing Climber



W/O Roof 00



Pyramid Roof 11



Leaf Roof 12



Shade Roof 13



NEW

I AM REVERSIBLE



## FAIRBANKS | QSWP-350068

Ages: 5-12  
Fall Height: 36"  
Use Zone: 31' x 25'  
Equipment Size: 18'9"x12'  
Timbers: 23

NATURE PRIMARY

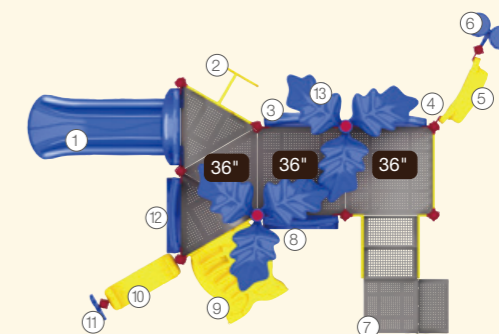

- ① 3ft Single Slide
- ② 3ft Wing Climber
- ③ Gears Panel
- ④ Beads & Cups Panel
- ⑤ Counter Panel
- ⑥ Bongo
- ⑦ ADA 4ft Transfer Station
- ⑧ World Map Panel
- ⑨ 2ft/3ft Fish Climber
- ⑩ Saddle Seat
- ⑪ Rain Wheel
- ⑫ Window Panel
- ⑬ Palm Topper



Palm Topper 06



Pyramid Roof 11



Leaf Roof 12



Shade Roof 13





**NEW**



## NONNY I | QSWP-350069

Ages: 5-12  
Fall Height: 84"  
Use Zone: 43'x21'  
Equipment Size: 31'x8'9"  
Timbers: 27

**NATURE**      **PRIMARY**

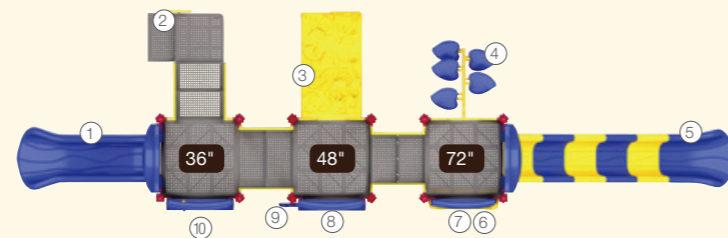
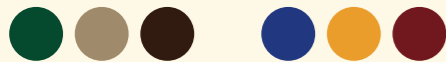

- ① 3ft Single Slide
- ② ADA 4ft Transfer Station
- ③ 4ft/5ft Rock Climber
- ④ 6ft Leaf Step Climber
- ⑤ 6ft Sectional Slides
- ⑥ 4ft/5ft Rock Climber
- ⑦ Saddle Seat (Below)
- ⑧ World Map Panel
- ⑨ Rain Wheel
- ⑩ Gears Panel



W/O Roof 00



Pyramid Roof 11



Leaf Roof 12



Shade Roof 13



## BONGO PLAY | QSWP-350011

Ages: 5-12  
Fall Height: 72"  
Use Zone: 39'x26'  
Equipment Size: 26'9"x13'11"  
Timbers: 27

**NATURE**      **PRIMARY**

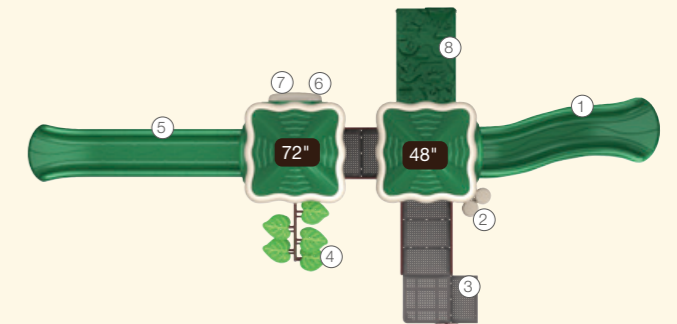

- ① 4ft Single Slide
- ② Bongo
- ③ 4ft ADA Stairs
- ④ 4ft Leaf Step Climber
- ⑤ 6ft Sectional Slides
- ⑥ Counter Panel (Below)
- ⑦ Gears Panel
- ⑧ 4ft/5ft Rock Climber



W/O Roof 00



Pyramid Roof 11



Leaf Roof 12



Shade Roof 13





NEW



## JURASSIC I QSWP-350040

Ages: 2-5  
Fall Height: 48"  
Use Zone: 34'x26'  
Equipment Size: 22'x14'5"  
Timbers: 26

NATURE PRIMARY

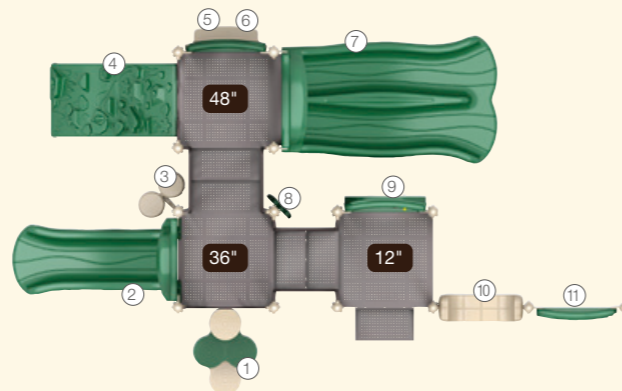
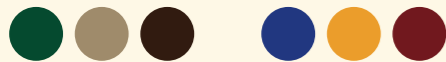

- ① 3ft Trunk Climber
- ② 3ft Single Slide
- ③ Bongo
- ④ 4ft/5ft Rock Climber
- ⑤ Beads & Cups Panel(Above)
- ⑥ Counter Panel(Below)
- ⑦ 4ft Double Slide
- ⑧ Rain Wheel
- ⑨ Gears Panel
- ⑩ Saddle Seat
- ⑪ Maze Panel



W/O Roof 00



Pyramid Roof 11



Leaf Roof 12



Shade Roof 13



NEW



## MINNIE I QSWP-350041

Ages: 2-5  
Fall Height: 36"  
Use Zone: 26' x 18'  
Equipment Size: 14'x6'  
Timbers: 20

NATURE PRIMARY

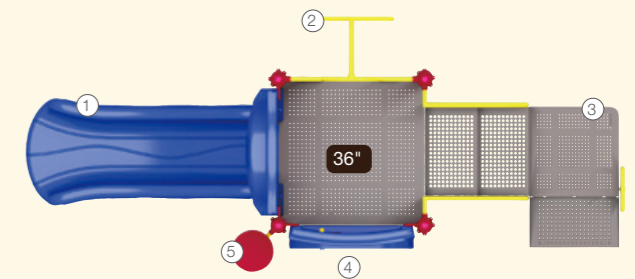

- ① 3ft Single Slide
- ② 3ft Snake Climber
- ③ ADA 3ft Transfer Station
- ④ Gears Panel
- ⑤ PE Stool



W/O Roof 00



Pyramid Roof 11



Leaf Roof 12



Shade Roof 13





NEW



## BOBBIE | QSWP-350042

Ages: 2-5  
Fall Height: 36"  
Use Zone: 32' x 22'  
Equipment Size: 19'3" x 13'9"  
Timbers: 24

NATURE PRIMARY

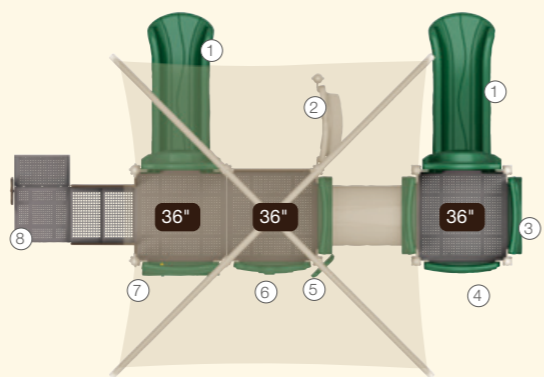
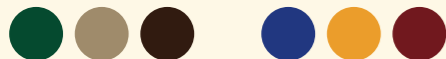

- ① 3ft Single Slide
- ② Counter Panel
- ③ World Map Panel
- ④ Beads & Cups Panel
- ⑤ Rain Wheel
- ⑥ Safety Panel
- ⑦ Gears Panel
- ⑧ ADA 3ft Transfer Station



W/O Roof 00



Pyramid Roof 11



Leaf Roof 12



Shade Roof 13



NEW



## WINDER | QSWP-350058

Ages: 2-5  
Fall Height: 60"  
Use Zone: 31' x 30'  
Equipment Size: 18'9" x 17'2"  
Timbers: 26

NATURE PRIMARY

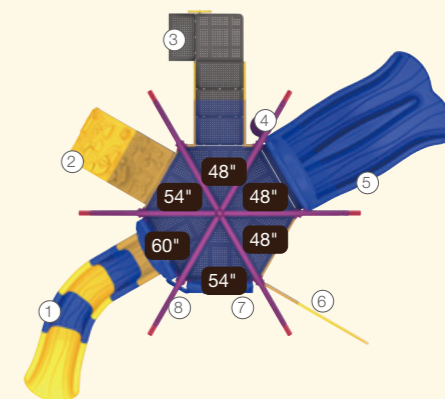

- ① 5ft Sectional Slide 45° Left Turn
- ② ADA 3ft Transfer Station
- ③ PE Stool
- ④ 4ft/5ft Rock Climber
- ⑤ 4ft Double Slide
- ⑥ Sail PE Climbing Panel
- ⑦ Gears Panel
- ⑧ Rain Wheel



W/O Roof 00



Leaf Roof 32



Shade Roof 33





**NEW**



### PLAY TIME | QSWP-350010

Ages: 2-5  
Fall Height: 48"  
Use Zone: 41'x28'  
Equipment Size: 28'11"x15'2"  
Timbers: 28

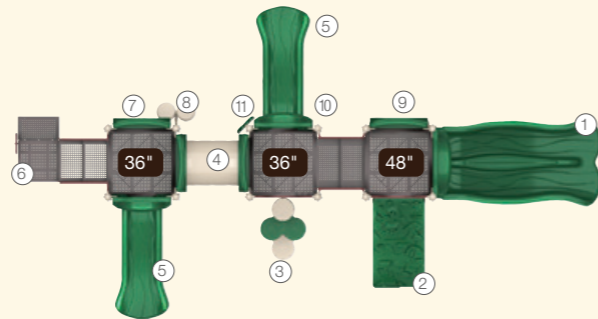

- ① 4ft Double Slide
- ② 4ft/5ft Rock Climber
- ③ 3ft Trunk Climber
- ④ 31" Crawl Tunnel
- ⑤ 3ft Single Slide
- ⑥ ADA 4ft Transfer Station
- ⑦ Large Window Panel
- ⑧ Bongo
- ⑨ World Map Panel
- ⑩ Saddle Seat
- ⑪ Rain Wheel

#### NATURE PRIMARY

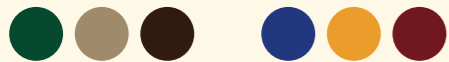

### ZAK | QSWP-350060

Ages: 2-5  
Fall Height: 60"  
Use Zone: 58' x 19'  
Equipment Size: 45'4"x6'11"  
Timbers: 35

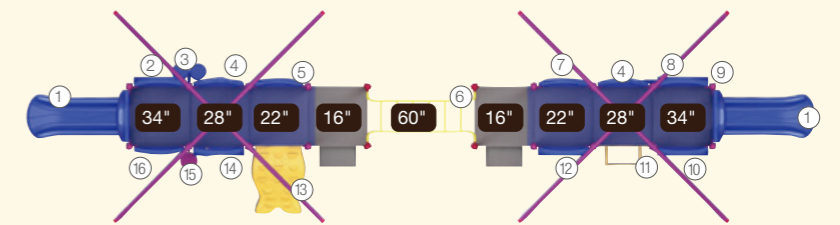

- ① 3ft Single Slide
- ② ABC Panel
- ③ Bongo
- ④ Safety Panel
- ⑤ Beads & Cups Panel
- ⑥ Challenge Ladder
- ⑦ Maze Panel
- ⑧ Rain Wheel
- ⑨ Four in A Row Panel
- ⑩ Clear Panel
- ⑪ 3ft Straight Rung Climber
- ⑫ World Map Panel
- ⑬ 3ft Fish Climber
- ⑭ Gears Panel
- ⑮ PE Stool
- ⑯ Puzzle Panel

#### NATURE PRIMARY



W/O Roof 00



Pyramid Roof 11



Leaf Roof 12



Shade Roof 13



W/O Roof 00



Pyramid Roof 11



Leaf Roof 12



Shade Roof 13





**NEW**



## SUNNY DAYS | QSWP-350004

Ages: 2-5  
Fall Height: 36"  
Use Zone: 30' x 25'  
Equipment Size: 17'5" x 12'11"  
Timbers: 24

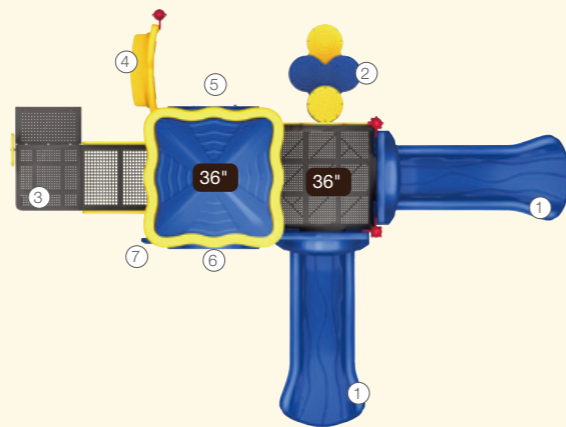

**NATURE** **PRIMARY**  
● ● ● ● ● ●



- ① 3ft Single Slide
- ② 3ft Trunk Climber
- ③ ADA 3ft Transfer Station
- ④ Counter Panel
- ⑤ Gears Panel
- ⑥ Four In A Row Panel
- ⑦ Rain Wheel

## TURTLE ISLAND | QSWP-350056

Ages: 2-5  
Fall Height: 36"  
Use Zone: 30' x 28'  
Equipment Size: 17'11" x 15'11"  
Timbers: 25

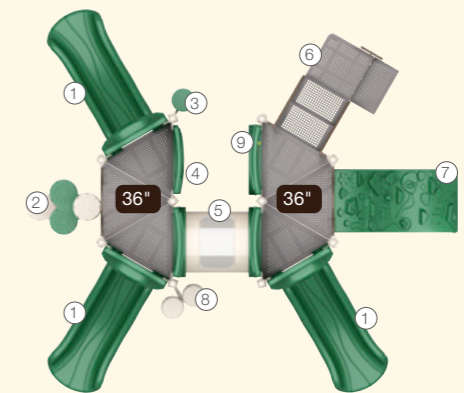

**NATURE** **PRIMARY**  
● ● ● ● ● ●



- ① 3ft Single Slide
- ② 3ft Trunk Climber Inground Footer
- ③ PE Stool
- ④ Beads & Cups Panel
- ⑤ 31" Crawl Tunnel
- ⑥ ADA 4ft Transfer Station
- ⑦ 4ft/5ft Rock Climber
- ⑧ Bongo
- ⑨ Gears Panel



W/O Roof 00



Pyramid Roof 11



Leaf Roof 12



Shade Roof 13



W/O Roof 00



Palm Topper 06



Pine Topper 07





## SUNNY STACK | QSWP-350017

Ages: 2-5  
 Fall Height: 48"  
 Use Zone: 28'x23'  
 Equipment Size: 16'1"x10'10"  
 Timbers: 23

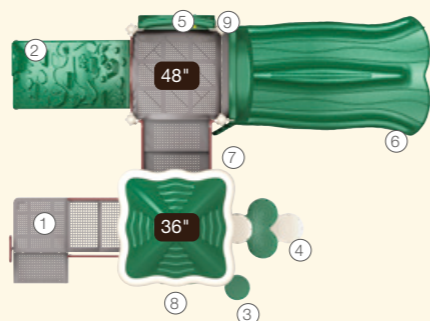

- ① ADA 3ft Transfer Station
- ② 4ft/5ft Rock Climber
- ③ PE Stool
- ④ 3ft Trunk Climber
- ⑤ Gears Panel
- ⑥ 4ft Double Slide
- ⑦ Rain Wheel
- ⑧ Maze Panel
- ⑨ Saddle Seat(Below)



W/O Roof 00



Pyramid Roof 11



Leaf Roof 12



Shade Roof 13



## JEREMY | QSWP-350043

Ages: 2-5  
 Fall Height: 36"  
 Use Zone: 27' x 17'  
 Equipment Size: 14'1"x4'8"  
 Timbers: 24

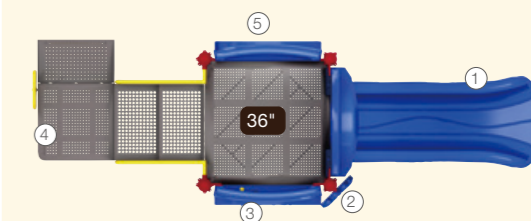

- ① 3ft Single Slide
- ② Rain Wheel
- ③ Gears Panel
- ④ ADA 3ft Transfer Station
- ⑤ Four in A Row Panel



W/O Roof 00



Pyramid Roof 11



Leaf Roof 12



Shade Roof 13



## KIDZ BUS | QS76-21079

Ages: 2-5  
 Fall Height: 36"  
 Use Zone: 23'x14'  
 Equipment Size: 16'4"x8'6"  
 Timbers: 28

### COLOR

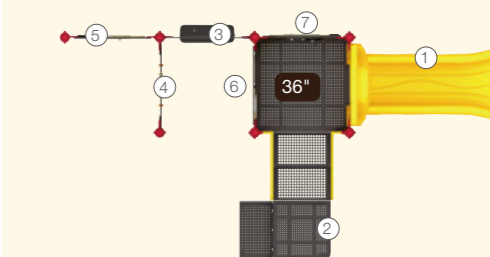

- ① 3ft Single Slide
- ② ADA 3ft Transfer Station
- ③ ADA Version
- ④ School Bus - Steering Wheel Panel
- ⑤ School Bus - Engine Panel
- ⑥ School Bus - Window Panel
- ⑦ School Bus - Gears Panel





# WisePLAY Inclusive Quick Ship

All-inclusive playgrounds are accessible, but not all accessible playgrounds are inclusive. At Wisdom Playgrounds we understand that we are not just designing our structures for the children. We know it takes a village to raise a child, which is why we always accommodate the parents and caregivers of various abilities that utilize our equipment. Following some fundamental principals, an inclusive playground will ensure that everyone can access the best play activities on the playground.

A crucial element to making an inclusive playground work for everyone is co-locating various kinds of the same type of activity so that someone who may have limited physical abilities can enjoy the same activity as the person close to them on a similar but perhaps more challenging activity. At Wisdom, we can all play together.

WisePLAY Inclusive playgrounds are artistically crafted with 3.5" OD galvanized steel support posts which allows the structure to be lighter, and more versatile. Without sacrificing features such as safety or durability, we accommodate getting you a high quality playgrounds packed full of activities.



Quick Ship WisePLAY Inclusive



3.5" Post ADA



## MEMPHIS | QSWP-350037

Ages: 5-12

Fall Height: 60"

Use Zone: 56'x42'

Equipment Size: 43'9"x29'11"

Timbers: 39

### NATURE



### PRIMARY

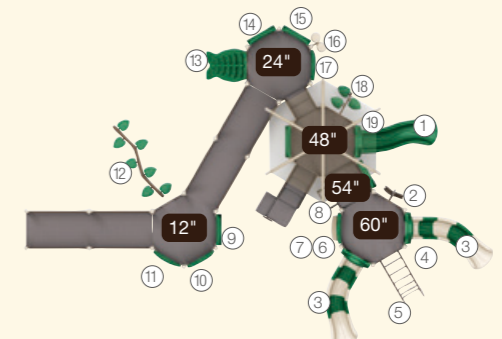

- ① 4ft Sectional Slide Left Turn
- ② 5ft Wing Climber
- ③ 5ft Sectional Slide Left Turn
- ④ ABC Panel(Below)
- ⑤ 5ft Arch Climber
- ⑥ Beads & Cups Panel(Above)
- ⑦ Counter Panel (Below)
- ⑧ 5ft Straight Rung Climber
- ⑨ World Map Panel
- ⑩ Puzzle Panel
- ⑪ Maze Panel
- ⑫ Balance Steps
- ⑬ 2ft/3ft Fish Climber
- ⑭ Four In A Row Panel
- ⑮ Clear Panel
- ⑯ Bongo
- ⑰ Beads & Cups Panel
- ⑱ World Map Panel (Below)



W/O Roof 00



Leaf Roof 32



Shade Roof 33





NEW



### ATLANTA | QSWP-350038

Ages: 5-12  
Fall Height: 48"  
Use Zone: 41'x35'  
Equipment Size: 29'x22'8"  
Timbers: 33

#### NATURE



#### PRIMARY

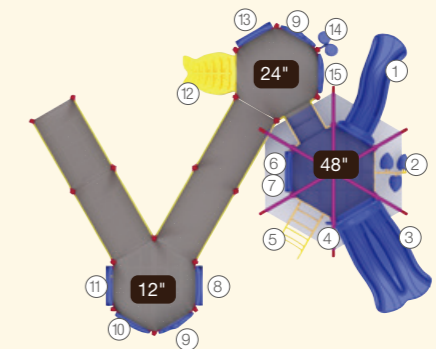

- ① 4ft Single Slide
- ② 4ft Leaf Step Climber
- ③ 4ft Double Slide
- ④ Rain Wheel
- ⑤ 4ft Arch Climber
- ⑥ ABC Panel(Above)
- ⑦ Saddle Seat (Below)
- ⑧ Saddle Seat (Below)
- ⑨ Safety Panel
- ⑩ Maze Panel
- ⑪ Gears Panel
- ⑫ 2ft/3ft Fish Climber
- ⑬ Four In A Row Panel
- ⑭ Bongo
- ⑮ Beads & Cups Panel



W/O Roof 00



Leaf Roof 32



Shade Roof 33



# WiseTOT Quick Ship

WiseTOT Quick Ship playgrounds are a great solution for anyone that needs to enhance their facility with quality play space and needs to do so quickly. As the name suggests, WiseTOT Quick Ships can be on-site in as little as 3-5 days. The WiseTOT series was developed with the little ones in mind. WiseTot's colorful and playful designs encourage children to explore all elements of play that are incorporated in these structures. Sensory processing plays a crucial role in the development of fine motor skills and mood regulation, which are necessary skills for children to help identify and manage their emotions in appropriate ways. Wisdom's WiseTOT series are built to last and be a place where tots can explore and have fun! Featuring sensory elements like sight to sound, and touch and feel to keep their minds and bodies engaged. WiseTOT structures are loaded with shapes, colors, and moving parts to provide endless amounts of entertainment.



Quick Ship



WiseTOT

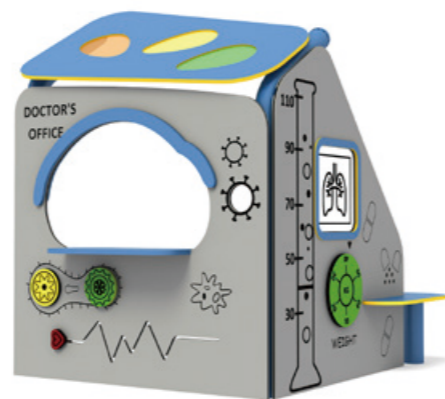

**WISE DOC**  
**QS76-21003**

Ages: 2-5  
Equipment Size: 5' x 5'



**WISE FIRE HOUSE**  
**QS76-21002**

Ages: 2-5  
Equipment Size: 5' x 6'



**WISE GARDENER**  
**QS76-21004**

Ages: 2-5  
Equipment Size: 5' x 5'







Play & Go



**NEW** **CHARLIE THE CHOOCHOO TRAIN**  
QSYJ001368  
Ages: 2-12  
Use Zone: 13'x10'



**NEW** **TUGBOAT TOM**  
QSYJ001370  
Ages: 2-12  
Use Zone: 13'x10'



**NEW** **SKY COPTER SAM**  
QSYJ001367  
Ages: 2-12  
Use Zone: 14'x11'



**NEW** **BERNICE THE BUS**  
QS76AM-003  
Ages: 2-12  
Use Zone: 14'x12'



**NEW** **FRANNY THE FIRE TRUCK**  
QSYJ001369  
Ages: 2-12  
Use Zone: 13'x10'



**NEW** **ZOOMSTER**  
QSYJ001366  
Ages: 2-12  
Use Zone: 12'x10'

RETRO Play & Go



**NEW** **HAPPY HARVESTER**  
QSYJ001318  
Ages: 2-12  
Use Zone: 10'x12'



**NEW** **7 SEAS**  
QSYJ001320-V01  
Ages: 2-12  
Use Zone: 10'x13'





**NEW**



### SEQUOIA | QSWP-350057

Ages: 6-23 Months

Use Zone: 32'x17'

Equipment Size: 20'4"x11'

Timbers: 19

**NATURE**



**PRIMARY**

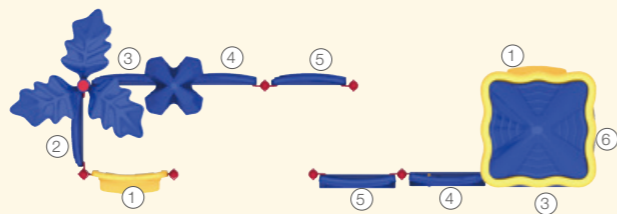

- ① Counter Panel
- ③ Beads & Cups Insert
- ⑤ Puzzle Insert

- ② World Map Panel
- ④ Maze Insert
- ⑥ Clock Insert



W/O Roof 00



Pyramid Roof 11



Leaf Roof 12



Shade Roof 13



**NEW**



### WIGGLE WORM | QSWP-350047

Ages: 6-23 Months

Use Zone: 21'x14'

Equipment Size: 14'8"x7'11"

Timbers: 18

**NATURE**



**PRIMARY**

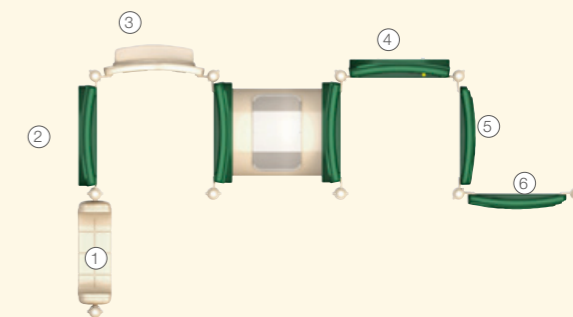

- ① Saddle Seat
- ③ Counter Panel
- ⑤ Puzzle Panel

- ② World Map Panel
- ④ Gears Panel
- ⑥ Maze Panel



W/O Roof 00



Pyramid Roof 11



Leaf Roof 12



Shade Roof 13





NEW



## GALILEO | QSWP-350052

Ages: 6-23 Months

Use Zone: 17'x18'

Equipment Size: 10'3"x11'11"

Timbers: 15

NATURE



PRIMARY

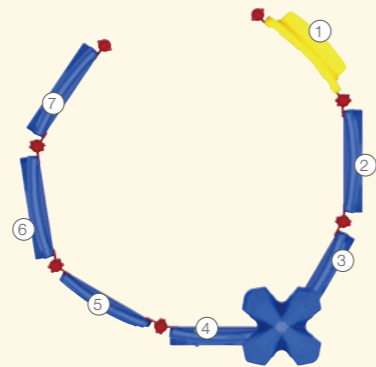

- ① Beads & Cups Panel
- ③ World Map Panel
- ⑤ Puzzle Panel
- ⑦ ABC Panel

- ② Jungle Adventure Insert
- ④ Gears Panel
- ⑥ Four In A Row Panel



W/O Roof 00



Palm Topper 06



Pine Topper 07



NEW



## HIDEOUT | QSWP-350054

Ages: 6-23 Months

Use Zone: 22'x18'

Equipment Size: 15'5"x11'9"

Timbers: 16

NATURE



PRIMARY

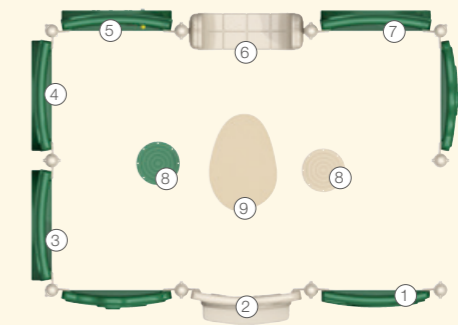

- ① Maze Panel
- ③ Four In A Row Panel
- ⑤ Gears Panel
- ⑦ World Map Panel
- ⑨ PE Table

- ② Counter Panel
- ④ ABC Panel
- ⑥ Saddle Seat
- ⑧ 12" Single Trunk Climber



W/O Roof 00



Palm Topper 06



Pine Topper 07





NEW



## ASHTON I | QSWP-350055

Ages: 6-23 Months

Fall Height: 24"

Use Zone: 19'x23'

Equipment Size: 12'4"x14'8"

Timbers: 19

NATURE



PRIMARY

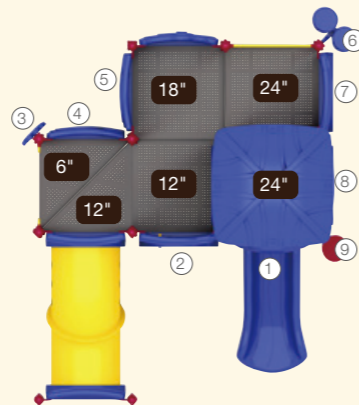

① 2ft Single Slide

③ Rain Wheel

⑤ Beads & Cups Panel

⑦ World Map Panel

⑨ PE Stool

② Gears Panel

④ Maze Panel

⑥ Bongo

⑧ Large Window Panel



W/O Roof 00



Pyramid Roof 11



Leaf Roof 12



Shade Roof 13



NEW



## WORLD TRAVELER I | QSWP-350048

Ages: 6-23 Months

Fall Height: 48"

Use Zone: 17'x14'

Equipment Size: 12'4"x10'8"

Timbers: 15

NATURE



PRIMARY

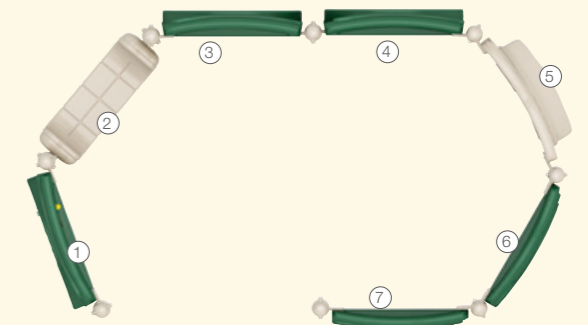

① Gears Panel

③ World Map Panel

⑤ Counter Panel

⑦ Maze Panel

② Saddle Seat

④ ABC Panel

⑥ Puzzle Panel



W/O Roof 00



Palm Topper 06



Pine Topper 07





## YESTERYEARS | QSWP-350007

Ages: 6-23 Months

Use Zone: 26'x21'

Equipment Size: 12'2"x15'5"

Timbers: 22

NATURE



PRIMARY

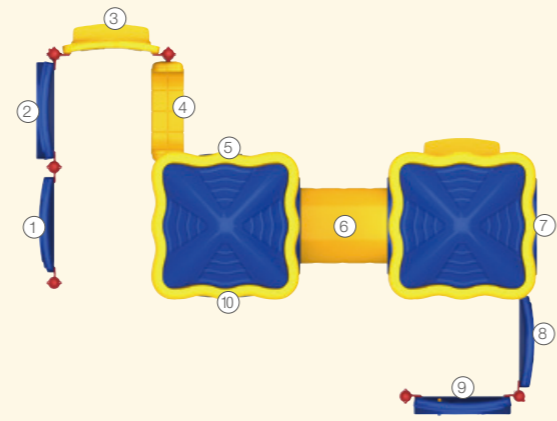

- ① Puzzle Panel
- ③ Counter Panel
- ⑤ Safety Panel
- ⑦ ABC Panel
- ⑨ Gears Panel

- ② Four In A Row Panel
- ④ Saddle Seat
- ⑥ 31" Crawl Tunnel
- ⑧ Maze Panel
- ⑩ Beads & Cups Panel



W/O Roof 00



Pyramid Roof 11



Leaf Roof 12



Shade Roof 13



## KIDZ CORNER | QSWP-350024

Ages: 6-23 Months

Use Zone: 15'x15'

Equipment Size: 8'7"x8'7"

Timbers: 19

NATURE



PRIMARY

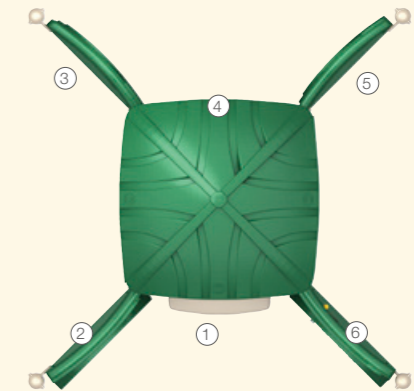

- ① Counter Panel
- ③ Beads & Cups Panel
- ⑤ Saddle Seat

- ② ABC Panel
- ④ Maze Panel
- ⑥ Gears Panel



W/O Roof 00



Pyramid Roof 11



Leaf Roof 12



Shade Roof 13





NEW



## BITTERROOT | QSWP-350051

Ages: 6-23 Months

Fall Height: 12"

Use Zone: 22'x20'

Equipment Size: 15'2"x13'5"

Timbers: 18

NATURE



PRIMARY

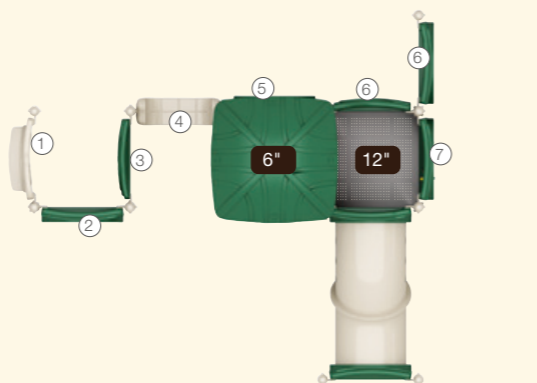

- ① Counter Panel
- ③ Maze Panel
- ⑤ Big Window Panel
- ⑦ Maze Panel

- ② Four In A Row Panel
- ④ Saddle Seat
- ⑥ World Map Panel



W/O Roof 00



Pyramid Roof 11



Leaf Roof 12



Shade Roof 13



NEW



## FALKVILLE | QSWP-350049

Ages: 6-23 Months

Fall Height: 24"

Use Zone: 19'x22'

Equipment Size: 12'4"x12'9"

Timbers: 18

NATURE



PRIMARY

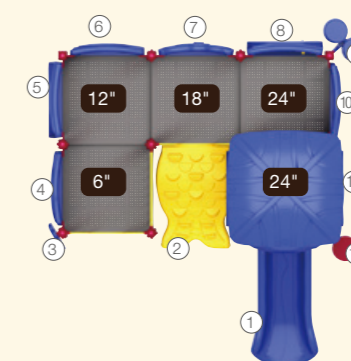

- ① 3ft Single Slide
- ③ Rain Wheel
- ⑤ ABC Panel
- ⑦ Safety Panel
- ⑨ Bongo
- ⑪ Clear Panel

- ② 2ft/3ft Fish Climber
- ④ Puzzle Panel
- ⑥ Maze Panel
- ⑧ Gears Panel
- ⑩ Beads & Cups Panel
- ⑫ PE Stool



W/O Roof 00



Pyramid Roof 11



Leaf Roof 12



Shade Roof 13





## TIME FLYER | QSWP-350053

Ages: 6-23 Months

Use Zone: 15'x18'

Equipment Size: 12'3"x19'4"

Timbers: 16

NATURE



PRIMARY

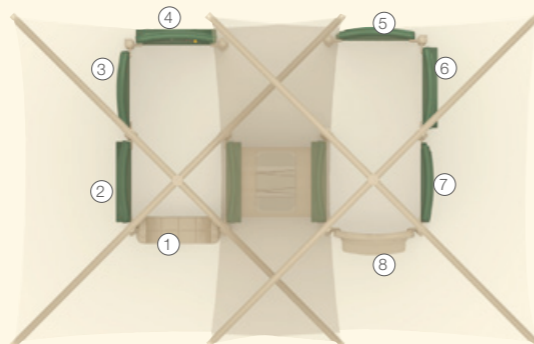

- ① Saddle Seat
- ③ Maze Panel
- ⑤ Puzzle Panel
- ⑦ Beads & Cups Panel

- ② ABC Panel
- ④ Gears Panel
- ⑥ Four In A Row Panel
- ⑧ Counter Panel



W/O Roof 00



Pyramid Roof 11



Leaf Roof 12



Shade Roof 13



## ASTER | QSWP-350050

Ages: 6-23 Months

Fall Height: 30"

Use Zone: 19'x22'

Equipment Size: 12'4"x12'8"

Timbers: 19

NATURE



PRIMARY

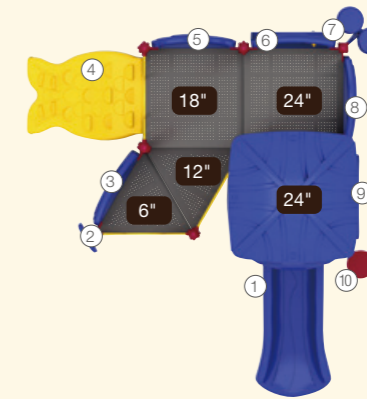

- ① 3ft Single Slide
- ③ Puzzle Panel
- ⑤ Safety Panel
- ⑦ Bongo
- ⑨ Clear Panel

- ② Rain Wheel
- ④ 2ft/3ft Fish Climber
- ⑥ Gears Panel
- ⑧ Beads & Cups Panel
- ⑩ PE Stool



W/O Roof 00



Pyramid Roof 11



Leaf Roof 12



Shade Roof 13





3.5 6-23 MONTHS

### PIKES PEAK | QSWP-350013

Ages: 6-23 Months

Use Zone: 14'x13'

Equipment Size: 7'6"x7'

Timbers: 17

#### NATURE



#### PRIMARY

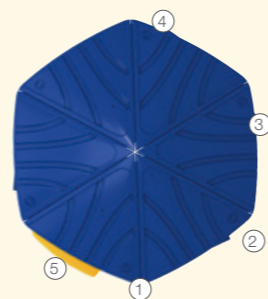

- ① Counter Panel
- ② ABC Panel
- ③ Gears Panel

- ④ Four In A Row Panel
- ⑤ Saddle Seat



W/O Roof 00



Leaf Roof 32



Shade Roof 33



3.5 6-23 MONTHS

### QUEEN THYME | QSBS35CS-0011

Ages: 6-23 Months

Use Zone: 11'x11'

Equipment Size: 4'7"x4'5"

Timbers: 11

#### COLOR

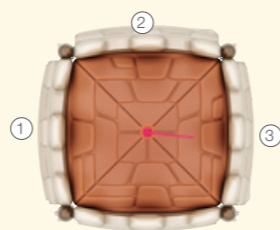

- ① Crocodile Puzzle Insert
- ③ Gears Panel

- ② World Map Panel



5.0 6-23 MONTHS

### LEAVES OF THYME | QSAT50TH-0008-NG

Ages: 6-23 Months

Use Zone: 16'x16'

Equipment Size: 10'x9'4"

Timbers: 13

#### COLOR

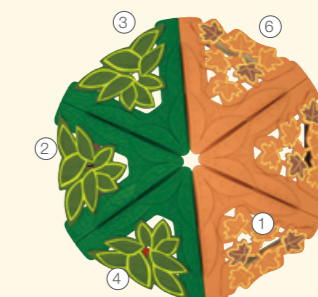

- ① Hex Leaf Roof
- ③ Gears Panel
- ⑤ Kitchen Panel

- ② Small Crocodile Puzzle Insert
- ④ Four In A Row Panel
- ⑥ Counter Panel



# WiseNEX Quick Ship

Part of the WiseWORX Series, WiseNEX features ropes that make outdoor play more engaging. WiseNEX is the perfect solution for any community that is in need of a more physically challenging play structure. This series involves a large variety of climbing, hanging, and balance pieces, to create imaginative play spaces combined with adventure. These structures provide numerous building blocks for overall coordination; attention and concentration, body awareness, muscular endurance, sensory processing, and isolated movement, which are some of the many building blocks this series provides.



## TRAIL BLAZER | QSFS-CL0017

Ages: 5-12  
Fall Height: 84"  
Use Zone: 42'x43'  
Equipment Size: 29'x9'31"

### NATURE



### PRIMARY

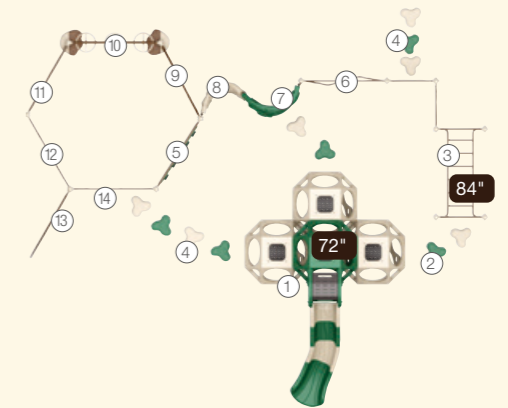

- ① Skqube
- ② 6" Clover Step
- ③ Challenge Ladder
- ④ 18" Clover Step
- ⑤ Net Climber-Grass & Ladybug
- ⑥ S Balance Bridge
- ⑦ Vertical Rock Climber-L
- ⑧ Vertical Rock Climber-S
- ⑨ Honeycomb Net Climber
- ⑩ Single Post Overhead Rotating Rings
- ⑪ Net Climber-Ladder
- ⑫ Rung Challenge Climber
- ⑬ Sail PE Climbing Panel
- ⑭ Vertical Net Link



Quick Ship



WiseNEX



ADA





NEW



## DALLAS | QSFS-CL0013

Ages: 5-12  
Fall Height: 84"  
Use Zone: 44'x30'  
Equipment Size: 31'x7'18"

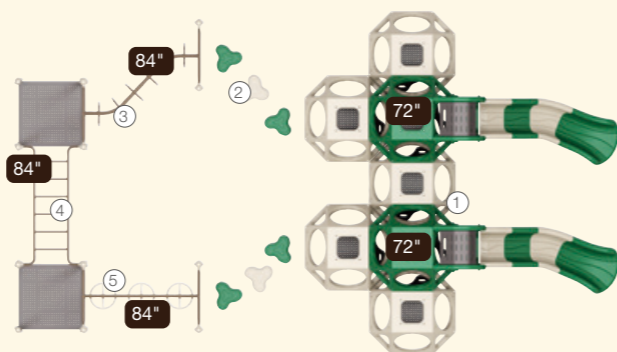

- ① Double Trouble Cube
- ② 6" Clover Step
- ③ Zig Zag Overhead Rings
- ④ Challenge Ladder
- ⑤ Overhead Rotating Rings



NEW



## QUICK STEP | QSFS-CL0016

Ages: 5-12  
Fall Height: 84"  
Use Zone: 31'x31'  
Equipment Size: 18'10"x18'4"

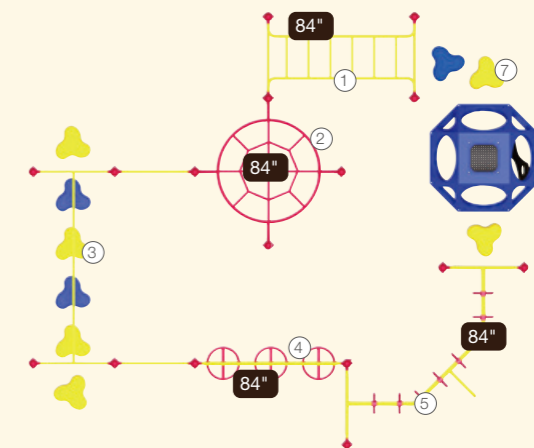

- ① Challenge Ladder
- ② Overhead Challenger
- ③ 4 Clover Steps Bridge
- ④ Overhead Rotating Rings
- ⑤ 90° Overhead Swinging Rings
- ⑥ Qubest
- ⑦ 6" Clover Step







## SPIDER QSFS-CL0015

Ages: 5-12  
Fall Height: 84"  
Use Zone: 30'x28'  
Equipment Size: 18'x15'6"

**NATURE**      **PRIMARY**

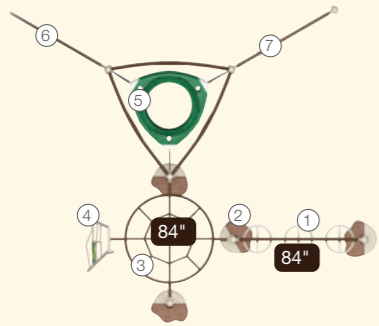

- ① Overhead Rotating Rings
- ② Bear Step
- ③ Overhead Challenger
- ④ 6ft PE Climber w/Deck
- ⑤ O-zone Climber
- ⑥ Sail PE Climbing Panel
- ⑦ Net Climber-Ladder



## MOOSE TRACKS QSFS-CL0026N

Ages: 5-12  
Fall Height: 12"  
Use Zone: 15' x 11'



① Bear Step

## THE CHALLENGER QSFS-CL0014

Ages: 5-12  
Fall Height: 84"  
Use Zone: 28'x31'  
Equipment Size: 15'11" x 18'1"

**NATURE**      **PRIMARY**

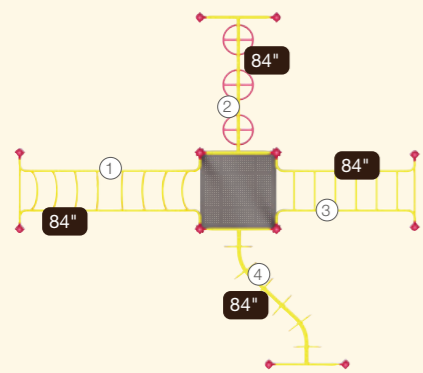

- ① Invert Arch Ladder
- ② Overhead Rotating Rings
- ③ Challenge Ladder
- ④ Zig Zag Overhead Rings

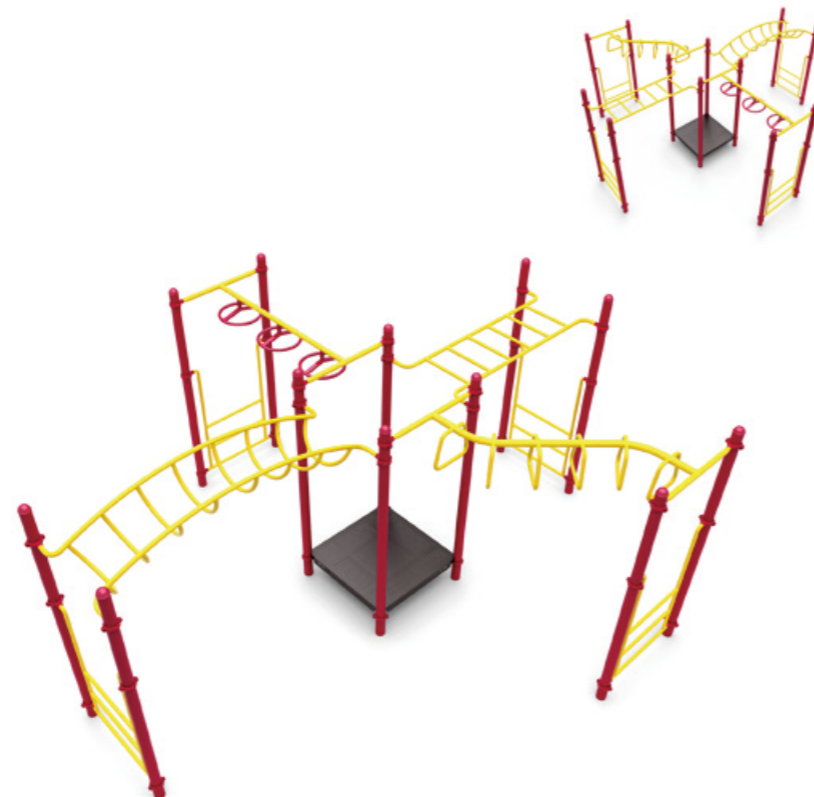

## LUCKY CLIMBER QSFS-CL0018N

Ages: 5-12  
Fall Height: 68"  
Use Zone: 28' x 20'

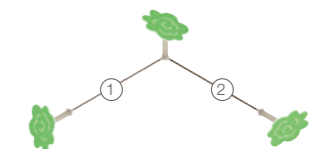

① Vertical Net Link  
② Power Rungs

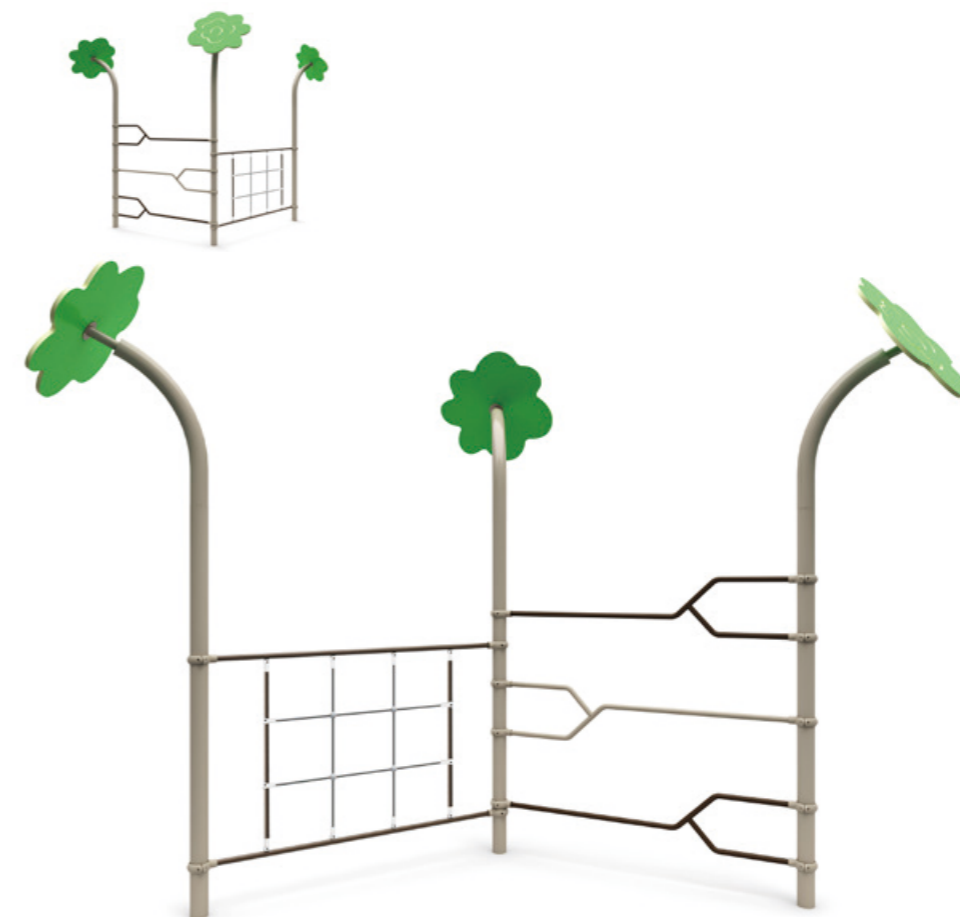



# WiseFREE Quick Ship

Wisdom offers a large variety of freestanding Quick Ship to add to any area. QuickShips are a great solution for religious organizations, daycares, multi-family housing, and schools and organizations that want to enhance their facility with quality items and need to do so quickly. When your timeline is tight, and you need to be mindful of the overall cost of purchasing, shipping, and installation, QuickShips are a great fit for you. When ordering a Quick Ship item, the standard delivery is 3 to 5 days from the time the order is placed. With ADA options available, these really can be an inclusive addition to any space.



Quick Ship



3.5" Post



ADA



## ARCH POST SWING

QSAS-350801

Color Option:  



**NEW**

## BUCKET TREE SWING

QSSPS-0801-TS

Color Option:  



## SINGLE POST SWING W/TOT ARM

QSSPS-0801-1A

Color Option:  



**NEW**

ADA SEAT

Color Option:  



FULL BUCKET SEAT



BELT SEAT



1FT GALVANIZED STEEL CHAIN



SINGLE CLEVIS CONNECTOR

Number	Description	Use Zone
AS-350801	3.5" Arch Swing Frame 8ft-1 Bay	24'x32'
AS-350802	3.5" Arch Swing Frame 8ft-2 Bay	36'x32'
AS-350803	3.5" Arch Swing Frame 8ft-3 Bay	48'x32'
AS-350804	3.5" Arch Swing Frame 8ft-4 Bay	60'x32'
SPS-0801	5" Single Post Swing 8ft-1 Bay	24'x32'
SPS-0802	5" Single Post Swing 8ft-2 Bay	36'x32'
SPS-0803	5" Single Post Swing 8ft-3 Bay	48'x32'
SPS-0804	5" Single Post Swing 8ft-4 Bay	60'x32'
SPS-0801-1A	5" Single Post Swing 8ft 1- Bay W/ARM	30'x32'
SPS-0801-TS	5" Single Post Swing Bucket Tree Swing	30'x32'
SS-0011	Full Bucket Seat & Galvanized Steel Chain Set	Sold Separately
SS-0012	Belt Seat & Galvanized Steel Chain Set	Sold Separately





Qubes



**QUBEST | QSQB-210001**

Age: 5-12  
Fall Height: 48"  
Use Zone: 17' x 17'

**NATURE PRIMARY**



**SKQUBE | QSQB-210002**

Age: 5-12  
Fall Height: 72"  
Use Zone: 24' x 29'

**NATURE PRIMARY**



**NEW**

**Q | QSQB-21097**

Age: 2-12  
Fall Height: 24"  
Use Zone: 17' x 17'

**NATURE PRIMARY**



**RUBY QUBE | QSQB-210004**

Age: 5-12  
Fall Height: 72"  
Use Zone: 23' x 23'

**NATURE PRIMARY**



Slides



**NEW**

**6' FREESTANDING SINGLE SLIDE  
QSFS-SL72031LS**

Ages: 5-12  
Fall Height: 72"  
Use Zone: 27' x 16'

**NATURE PRIMARY**



**NEW**

**5' FREESTANDING SINGLE SLIDE  
QSFS-SL6001WC**

Ages: 5-12  
Fall Height: 60"  
Use Zone: 24' x 17'

**NATURE PRIMARY**



Moab Rock

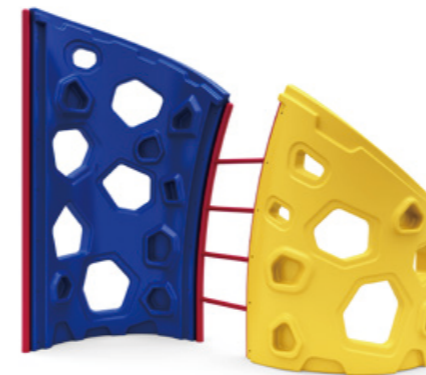

**DELICATE ARCH | QSMR-210002**

Ages: 5-12  
Fall Height: 83"  
Use Zone: 20' x 16'

**PRIMARY**



**BALANCED ROCK | QSMR-210001**

Ages: 5-12  
Fall Height: 83"  
Use Zone: 20' x 17'

**NATURE**







Spring Riders



**FIRE TRUCK RIDER | QSSR-21006**  
Ages: 2-5  
Use Zone: 15'x13'



**BEE RIDER | QSSR-21007**  
Ages: 2-5  
Use Zone: 15'x13'



**HORSE RIDER | QSSR-21008**  
Ages: 2-5  
Use Zone: 15'x13'



**PONY RIDER | QSSR-21004**  
Ages: 2-5  
Use Zone: 15'x14'



  
**CATERPILLAR CRAWL TUNNEL-UNIT  
QSHW1-S308**  
Ages: 2-5  
Use Zone: 11'x11'



  
**CATERPILLAR CRAWL TUNNEL-  
COMPLETE SET  
QSHW1-S309**  
Ages: 2-12  
Use Zone: 17'x13'





**GFRC TIMBER CRAWL TUNNEL**  
QS72-22001

Ages: 2-12  
Use Zone: 10' x 9'



**NEW**

**FROG HOPPER**  
QSFS-CL0019N

Ages: 2-12  
Use Zone: 17' x 17'



**STAND & SPIN** | QS75-21003

Ages: 5 -12  
Use Zone: 21' x 21'



**LOTUS SPINNER** | QS75-21004

Ages: 5 -12  
Use Zone: 20' x 20'



**NEW**

**TETHERBALL SET**  
QS72-21031



**BALANCE BEAM**  
QS75-21009-110

Ages: 2-12  
Use Zone: 13' x 6'



**NEW**

**WISE TOSS** | QSLS-JSQC006

Ages: 2-12  
Use Zone: 9' x 9'

Color Option: |



**NEW**

**PLAYGROUND BALLS (SET OF 6)**  
QS72-21032



**LEAF BALANCE STEPS**  
QS75-21012-111

Ages: 2-12  
Use Zone: 20' x 15'





Drawing



**NEW**  
WISE BLACKBOARD  
QS78-21001



**NEW**  
WISE WHITE BOARD  
QS78-21002

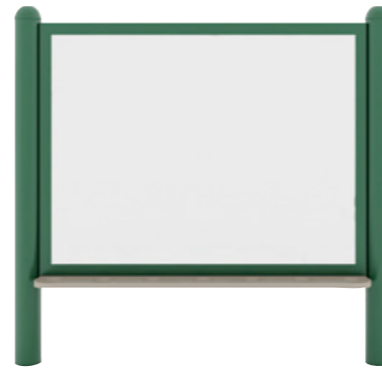

**NEW**  
WISE PAINT BOARD  
QS78-21003



**NEW**  
ALLIE THE APPLE  
QS78-21007



**NEW**  
FIONA THE FLOWER  
QS78-21008



**NEW**  
CAREY THE CARROT  
QS78-21006

Music



**NEW**  
ALTO  
QSFS-WP0001N



BONGO DRUMS  
QS72-22004



RAINBOW  
XYLOPHONE  
QS72-22003



SPLIT RAINBOW  
XYLOPHONE  
QS72-22002



# WiseSITE

## Quick Ship

Wisdom offers a large variety of Quick Ship site furnishings to add to any area. Quick Ships are a great solution for religious organizations, daycares, multi-family housing, and schools and organizations that want to enhance their facility with quality items and need to do so quickly. When your timeline is tight, and you need to be mindful of the overall cost of purchasing, shipping, and installation, Quick Ships are a great fit for you. When ordering a Quick Ship item, the standard delivery is 3 to 5 days from the time the order is placed. With ADA options available, WiseSITE options add an inclusive addition to any play space.



**12" TIMBER BORDER  
W/SPIKE**  
QSTB-5212-AP

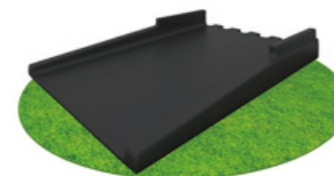

**HALF ADA RAMP**  
QSTB-6244-AP



**NEW**

**6' RECTANGULAR PICNIC TABLE  
PERFORATED PATTERN**  
QSSAP-21001-110



**NEW**

**6' BENCH W/BACK  
PERFORATED PATTERN**  
QSSAP-21002-110



**NEW**

**WISEBIN**  
QS72-21021-114



**NEW**

**WISEBIN  
WITH RAIN COVER**  
QS72-21022-110



**NEW**

**SINGLE BIKE RACK**  
QS72-21015-131



**NEW**

**DOUBLE BIKE RACK**  
QS72-21016-131



Quick Ship



# WiseTOT

The WiseTOT series was developed with the little ones in mind. WiseTot's colorful and playful designs encourage children to explore all elements of play that are incorporated in these structures. Sensory processing plays a crucial role in the development of fine motor skills and mood regulation, which are necessary skills for children to help identify and manage their emotions in appropriate ways. Wisdom's WiseTOT series are built to last and be a place where tots can explore and have fun! Featuring sensory elements like sight to sound, and touch and feel to keep their minds and bodies engaged. WiseTOT structures are loaded with shapes, colors, and moving parts to provide endless amounts of entertainment.

- 097 Lean on Me Series
- 107 WiseTOT Custom
- 111 Retro Play & GO



3.5  
WT

[www.wisdomplaygrounds.com](http://www.wisdomplaygrounds.com)



# WiseTOT

## Lean on Me Series

The WiseTOT Lean On Me Series was developed to let children release their passion for adventure in a safe environment and cultivate the learning ability to not be afraid of challenges. WiseTOT Imagination City playgrounds are part of the Lean On Me series, which integrates equipment that will keep the imagination going, along with special sensory integration that helps promote the balanced development of children's gross motor abilities and overall sensory abilities.

Imagination City provides the smaller children an option to explore their surroundings more autonomously and with interesting activities. Featuring sensory elements like sight, sound and touch, keeps their minds and bodies engaged. WiseTOT structures are loaded with shapes, colors, and moving parts to provide endless amounts of entertainment. Wisdom's variety of activities comprehensively develop children's different abilities.



WiseTOT



3.5" Post



ADA



NEW



### SEQUOIA | TOT35CL-0001

Ages: 6-23 Months  
 Fall Height: 24"  
 Use Zone: 32'x14'  
 Equipment Size: 22'5"x7'6"  
 Timbers: 20

#### SUNRISE

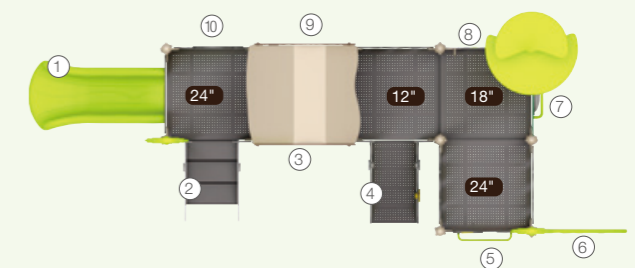

- ① 2ft Single Slide
- ② 2ft Stairs
- ③ PE Turntable Panel
- ④ 1ft Ramp
- ⑤ PE Duo-window Panel
- ⑥ Arch Climbing Panel
- ⑦ PE Bubble Window Panel
- ⑧ PE Tic-tac-toe Panel
- ⑨ PE Numbers & Shapes Panel
- ⑩ PE Tri-window Panel





## LITTLE SNUFFY

**TOT35CL-0009**

Ages: 6-23 Months

Fall Height: 24"

Use Zone: 18'x10'

Equipment Size: 11'10"x3'10"

Timbers: 14

### SUNRISE

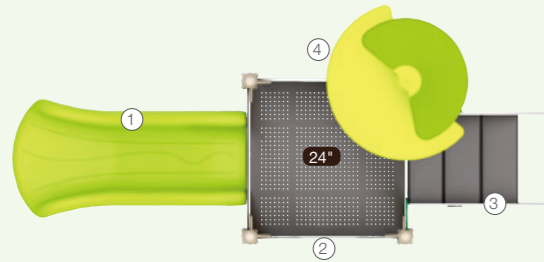

- ① 2ft Single Slide
- ② PE Elephant Panel L
- ③ 2ft Stairs
- ④ PE Elephant Panel R



## TOADS PLAY

**TOT35CL-0005**

Ages: 6-23 Months

Fall Height: 24"

Use Zone: 25'x14'

Equipment Size: 15'7"x7'4"

Timbers: 18

### TROPICAL

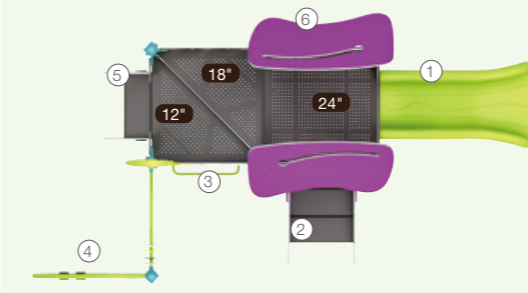

- ① 2ft Single Slide
- ② 2ft Stairs
- ③ PE Duo-window Panel
- ④ Arch Climbing Panel
- ⑤ 1ft Stairs
- ⑥ PE Numbers & Shapes Panel



## DAFFOIDIL

**TOT35CL-0013**

Ages: 6-23 Months

Fall Height: 24"

Use Zone: 17'x21'

Equipment Size: 10'2"x11'10"

Timbers: 17

### SUNRISE

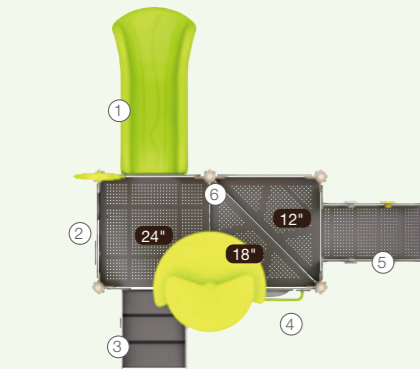

- ① 2ft Single Slide
- ② PE Turntable Panel
- ③ 2ft Stairs
- ④ PE Bubble Window Panel
- ⑤ 1ft Ramp
- ⑥ PE Safety Panel - Dynamic



## DAHLIA

**TOT35CL-0003**

Ages: 6-23 Months

Fall Height: 24"

Use Zone: 32'x34'

Equipment Size: 15'5"x15'8"

Timbers: 18

### TROPICAL

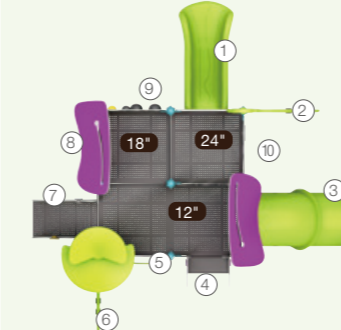

- ① 2ft Single Slide
- ② Arch Climbing Panel
- ③ Inclined Crawl Tunnel
- ④ Inclined Crawl Tunnel
- ⑤ PE Duo-window Panel
- ⑥ Arch Panel
- ⑦ 1ft Ramp
- ⑧ PE Numbers & Shapes Panel
- ⑨ PE Music Panel
- ⑩ PE Turntable Panel





**NEW**



## IRIS TOT35CL-0002

Ages: 6-23 Months  
Fall Height: 24"  
Use Zone: 26'x25'  
Equipment Size: 19'5"x16'  
Timbers: 21

### TRANQUIL



- ① 2ft Single Slide
- ② PE Tic-tac-toe Panel
- ③ PE Duo-window Panel
- ④ Inclined Crawl Tunnel
- ⑤ Growth Ring Stool
- ⑥ Leaf Table
- ⑦ PE Counter Panel
- ⑧ PE Hole Panel
- ⑨ PE Tri-window Panel
- ⑩ Arch Panel
- ⑪ PE Numbers & Shapes Panel
- ⑫ 1ft Stairs
- ⑬ PE Bubble Window Panel
- ⑭ Game Table



## COSMOS TOT35CL-0006

Ages: 6-23 Months  
Fall Height: 24"  
Use Zone: 21'x17'  
Equipment Size: 11'8"x10'8"  
Timbers: 16

### TRANQUIL

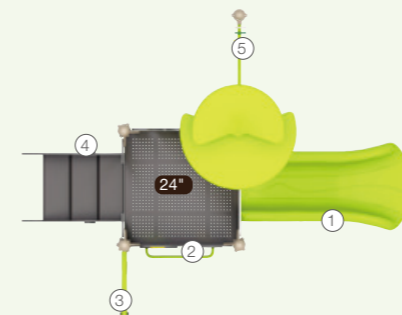

- ① 2ft Single Slide
- ② PE Duo-window Panel
- ③ Arch Panel
- ④ 2ft Stairs
- ⑤ Horizontal Moving Game



## POLLYWOGS TOT35CL-0010

Ages: 6-23 Months  
Fall Height: 6"  
Use Zone: 18'x14'  
Equipment Size: 11'2"x7'9"  
Timbers: 15

### TRANQUIL

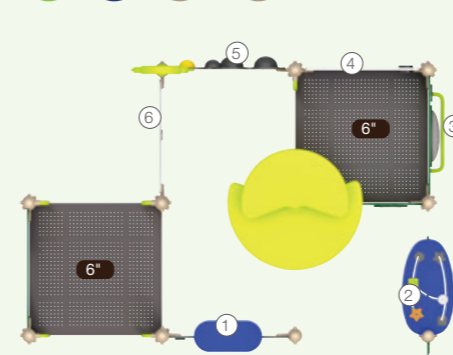

- ① PE Counter Panel
- ② Game Table
- ③ PE Bubble Window Panel
- ④ PE Numbers & Shapes Panel
- ⑤ PE Music Panel
- ⑥ Arch Panel





NEW



## MADELINE | TOT35CL-0004

Ages: 6-23 Months  
 Fall Height: 24"  
 Use Zone: 25'x14'  
 Equipment Size: 15'10"x7'3"  
 Timbers: 18

### HIGH TIDE

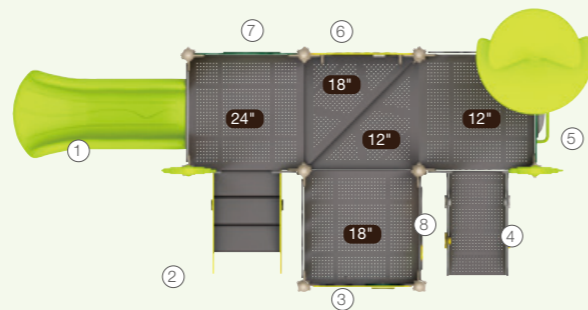

- ① 2ft Single Slide
- ③ PE Turntable Panel
- ⑤ PE Bubble Window Panel
- ⑦ PE Tri-window Panel
- ② 2ft Stairs
- ④ 1ft Ramp
- ⑥ PE Tic-tac-toe Panel
- ⑧ PE Duo-window Panel



NEW



## GNOMES HUT | TOT35CL-0011

Ages: 6-23 Months  
 Fall Height: 24"  
 Use Zone: 26'x17'  
 Equipment Size: 19'4"x7'7"  
 Timbers: 19

### HIGH TIDE

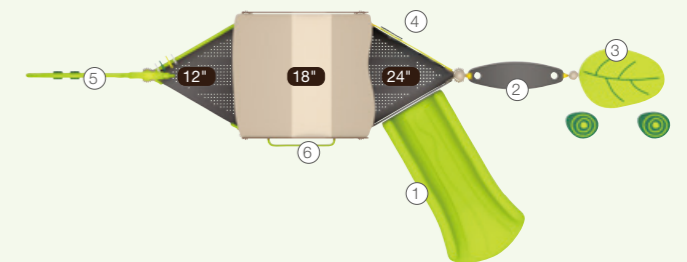

- ① 2ft Single Slide
- ③ Leaf Table
- ⑤ Arch Panel
- ② Growth Ring Stool
- ④ PE Turntable Panel
- ⑥ PE Duo-window Panel







**BEDELIA**  
**TOT35CL-0007**  
 Ages: 6-23 Months  
 Fall Height: 24"  
 Use Zone: 25'x15'  
 Equipment Size: 15'7"x8'11"  
 Timbers: 16

**HIGH TIDE**

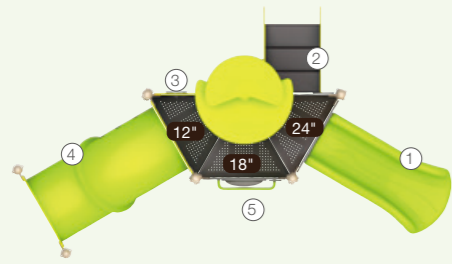

- ① 2ft Single Slide
- ② 2ft Stairs
- ③ PE Turntable Panel
- ④ Inclined Crawl Tunnel
- ⑤ PE Bubble Window Panel



**MARIGOLD**  
**TOT35CL-0008**  
 Ages: 6-23 Months  
 Use Zone: 17'x11'  
 Equipment Size: 10'1"x4'1"  
 Timbers: 13

**PARADISE**



- ① Crawl Tunnel
- ② PE Bubble Window Panel
- ③ PE Tic-tac-toe Panel
- ④ Arch Panel



**MAISY**  
**TOT35CL-0014**  
 Ages: 6-23 Months  
 Fall Height: 24"  
 Use Zone: 25'x14'  
 Equipment Size: 15'10"x7'3"  
 Timbers: 18

**HIGH TIDE**

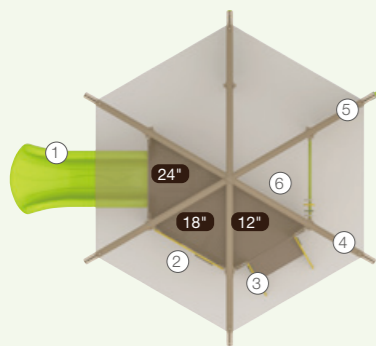

- ① 2ft Single Slide
- ② PE Turntable Panel
- ③ 1ft Stairs
- ④ Arch Panel
- ⑤ Arch Climbing Panel
- ⑥ PE Numbers & Shapes Panel



**PETUNIA**  
**TOT35CL-0012**  
 Ages: 6-23 Months  
 Fall Height: 12"  
 Use Zone: 13'x12'  
 Equipment Size: 6'9"x5'5"  
 Timbers: 11

**PARADISE**

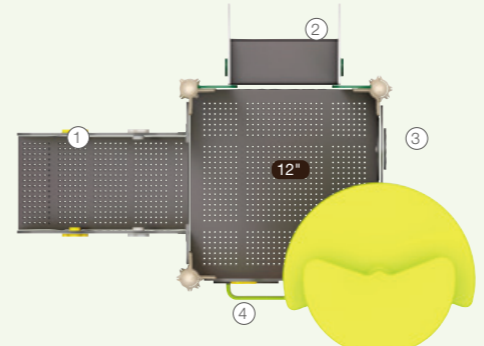

- ① 1ft Ramp
- ② 1ft Stairs
- ③ PE Turntable Panel
- ④ PE Duo-window Panel





# WiseTOT Custom

WiseTOT Custom playgrounds are built to last and be a place where young children can explore and create great adventures together. The custom WiseTOT structures come in a variety of color scheme options and are artistically crafted with the little ones in mind. Here at Wisdom Playgrounds, we accommodate making high quality playgrounds packed full of activities, without sacrificing features such as safety and durability. WiseTOT Custom playgrounds are a great solution for organizations that need a high quality playground for toddler age children.

WiseTOT structures are loaded with shapes, colors, and moving parts to provide endless amounts of entertainment. WiseTOT Custom designs have integrated equipment that will keep the imagination going, along with special sensory integration that help promote the balanced development of children's gross motor skills and overall sensory abilities.

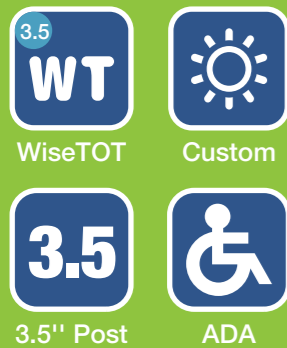

## TIPPY-TOE | PDWP-350090C13

Ages: 6-23 Months  
 Fall Height: 24"  
 Use Zone: 22'x19'  
 Equipment Size: 15'x4'13"  
 Timbers: 19

### COLOR

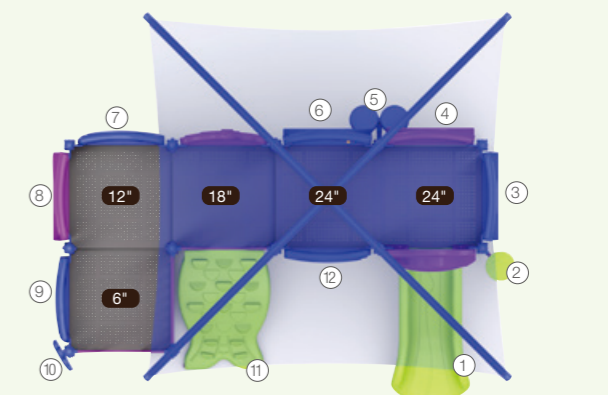

- ① 2ft Single Slide
- ② PE Stool
- ③ Bubble Window Insert
- ④ World Map Insert
- ⑤ Bongo
- ⑥ Gears Insert
- ⑦ Maze Insert
- ⑧ ABC Insert
- ⑨ Puzzle Insert
- ⑩ Rain Wheel
- ⑪ 2ft Fish Climber
- ⑫ Beads & Cups Insert



**NEW**



**ZOEY**  
**PDWP-350097C12**

Ages: 6-23 Months  
Use Zone: 18'x15'  
Equipment Size: 12'8"x11'  
Timbers: 14

**COLOR**

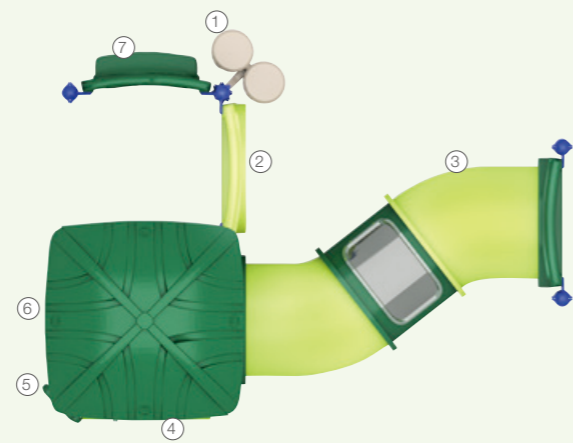

- ① Bongo
- ② Four In A Row Insert
- ③ S-shape Crawl Tunnel
- ④ Gears Insert
- ⑤ Rain Wheel
- ⑥ Saddle Seat
- ⑦ Counter Panel



**SWEET MAY**  
**PDWP-350098C11**

Ages: 6-23 Months  
Fall Height: 24"  
Use Zone: 23'x15'  
Equipment Size: 13'7"x8'10"  
Timbers: 17

**COLOR**

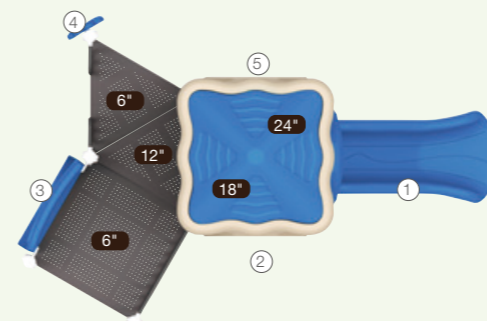

- ① 2ft Single Slide
- ② ABC Insert
- ③ World Map Insert
- ④ Rain Wheel
- ⑤ Bubble Window Insert



**LITTLE STAR**  
**PDWP-350099C11**

Ages: 6-23 Months  
Fall Height: 24"  
Use Zone: 22'x15'  
Equipment Size: 12'7"x8'3"  
Timbers: 16

**COLOR**

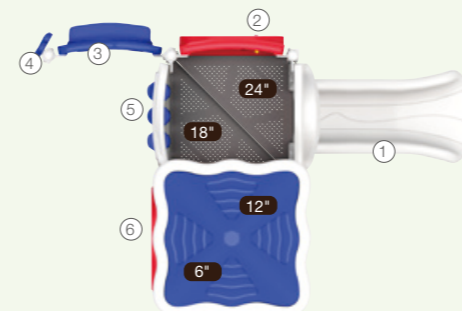

- ① 2ft Single Slide
- ② Gears Insert
- ③ Saddle Seat
- ④ Rain Wheel
- ⑤ Tic-Tac-Toe Insert
- ⑥ Bubble Window Insert





# WiseTOT

## Retro Play & GO

WiseTOT Retro Play & Go is a small series where children can explore and use their imagination with equipment that is stylized as modes of transportation. This exploratory equipment is built to last and be a place where children can explore and create great adventures together.

The Retro Play & Go is artistically crafted with the little ones in mind, and offers a great solution for organizations that need additional play items for toddler age children.

WiseTOT designs integrate a wide variety of equipment that will keep the imagination going, along with special sensory integration that help promote the balanced development of children's gross motor skills and overall sensory abilities.



**FIRE ENGINE**  
YJ001316-V01

Ages: 2-5  
Use Zone: 11'x9'

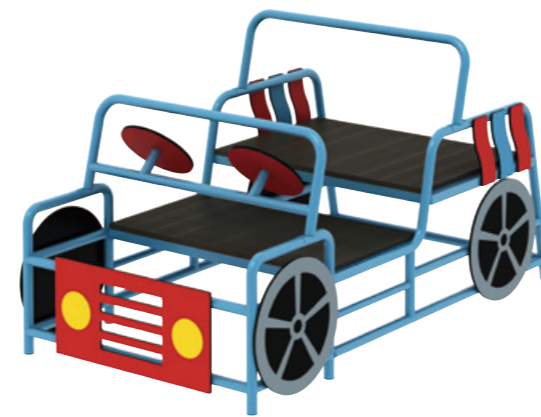

**BEEP JEEP**  
YJ001317-V01

Ages: 2-5  
Use Zone: 12'x9'



**AIRPLANE**  
YJ001319

Ages: 2-5  
Use Zone: 13'x11'



WiseTOT



# WisePLAY

Wisdom's WisePLAY structures are a great solution for organizations that want to enhance their facility with an exciting play space that has a slightly smaller footprint than the standard. WisePLAY structures are artistically crafted with 3.5" posts instead of 5" posts, which allows the structure to be lighter, and more versatile. Without sacrificing features such as safety and durability, we accommodate making high quality playgrounds packed full of activities. With the WisePLAY structures overall weight being smaller because of the pole size, this keeps the cost of purchasing the structure down, as well as the overall costs of shipping.

- 115 WisePLAY Inclusive
- 123 WisePLAY Custom
- 153 WisePLAY Theme



3.5

WP

[www.wisdomplaygrounds.com](http://www.wisdomplaygrounds.com)



# WisePLAY Inclusive

All-inclusive playgrounds are accessible, but not all accessible playgrounds are inclusive. At Wisdom Playgrounds we understand that we are not just designing our structures for the children. We know it takes a village to raise a child, which is why we always accommodate the parents and caregivers of various abilities that utilize our equipment. Following some fundamental principals, an inclusive playground will ensure that everyone can access the best play activities on the playground.

A crucial element to making an inclusive playground work for everyone is co-locating various kinds of the same type of activity so that someone who may have physical abilities can enjoy the same activity as the person close to them on a similar but perhaps more challenging activity. At Wisdom, we can all play together.

WisePLAY Inclusive playgrounds are artistically crafted with 3.5" OD galvanized steel support posts which allows the structure to be lighter, and more versatile. Without sacrificing features such as safety or durability, we accommodate getting you a high quality playgrounds packed full of activities.



**NEW**



## EVOLUTION | PDWP-350071C00

Ages: 2-12

Fall Height: 48"

Use Zone: 67'x48'

Equipment Size: 54'3"x35'1"x9'

### COLOR

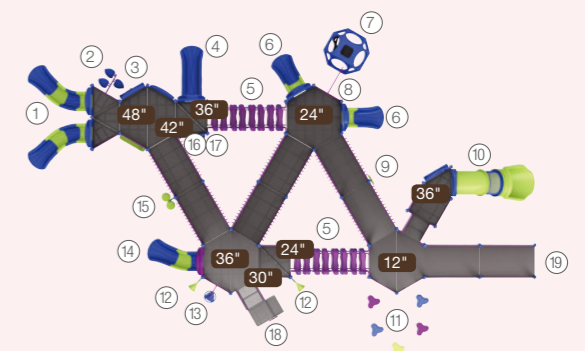

- ① 4ft Sectional Slide 45° Left Tur
- ② 4ft Leaf Step Climber
- ③ Maze Panel
- ④ 3ft Single Slide
- ⑤ 2ft Inclined Timber Arch Bridge
- ⑥ 2ft Sectional Slide
- ⑦ Qubest
- ⑧ Qubest Climber Entry
- ⑨ Rain Wheel
- ⑩ 1ft Tunnel Slide
- ⑪ 6" Clover Step
- ⑫ Talk Tube
- ⑬ 3ft Pod Climber
- ⑭ 3ft Sectional Slide Right Turn
- ⑮ Bongo
- ⑯ Four In A Row Panel (Above)
- ⑰ Saddle Seat (Below)
- ⑱ ADA Transfer Station



NEW



Rock and Roll ON

## WISE TRAVELER | PDWP-350072C33

Ages: 2-5  
 Fall Height: 48"  
 Use Zone: 50'x46'  
 Equipment Size: 37'1"x33'8"x11'10"

### COLOR

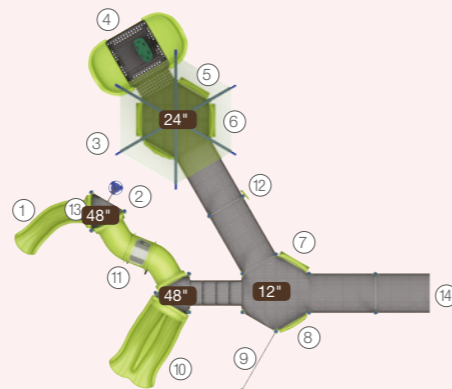

- |                                     |                       |
|-------------------------------------|-----------------------|
| ① 4ft Sectional Slide 45° Left Turn | ② 4ft Pod Climber     |
| ③ ABC Panel                         | ④ Rock and Roll ON    |
| ⑤ World Map Panel                   | ⑥ Four In A Row Panel |
| ⑦ Window Panel                      | ⑧ Beads & Cups Panel  |
| ⑨ Rung Challenge Climber            | ⑩ 4ft Double Slide    |
| ⑪ S-shape Crawl Tunnel              | ⑫ Rain Wheel          |
| ⑬ Saddle Seat                       | ⑭ ADA Ramp            |



NEW



## ISLAND WONDER | PDWP-350075C33

Ages: 2-12  
 Fall Height: 84"  
 Use Zone: 93'x38'  
 Equipment Size: 79'3"x25'10"x13'9"

### COLOR

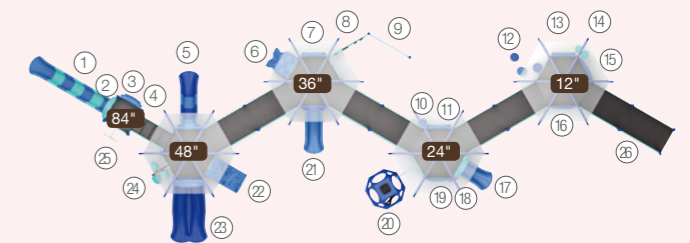

- |                               |                               |
|-------------------------------|-------------------------------|
| ① 7ft Sectional Slide         | ② Saddle Seat                 |
| ③ Four In A Row Panel (Above) | ④ Counter Panel (Below)       |
| ⑤ 4ft Sectional Slide         | ⑥ 2ft/3ft Fish Climber        |
| ⑦ Gears Panel                 | ⑧ Net Climber-Grass & Ladybug |
| ⑨ Net Climber-Ladder          | ⑩ PE Stool                    |
| ⑪ ABC Panel                   | ⑫ 12" Single Trunk Climber    |
| ⑬ World Map Panel             | ⑭ Bongo                       |
| ⑮ Beads & Cups Panel          | ⑯ Maze Panel                  |
| ⑰ 2ft Sectional Slide         | ⑱ Rain Wheel                  |
| ⑲ Puzzle Panel                | ⑳ Qubest                      |
| ㉑ 3ft Single Slide            | ㉒ 4ft/5ft Rock Climber        |
| ㉓ 4ft Double Slide            | ㉔ 4ft Leaf Step Climber       |
| ㉕ 7ft Snake Climber           | ㉖ ADA Ramp                    |





NEW



## CHARLOTTE'S FUN ZONE | PDWP-350073C00

Ages: 2-12  
 Fall Height: 96"  
 Use Zone: 56'x67'  
 Equipment Size: 43'6"x54'3"x15'9"

### COLOR



NEW



## WACKY WISE | PDWP-350074C33

Ages: 2-12  
 Fall Height: 96"  
 Use Zone: 45'x52'  
 Equipment Size: 32'2"x37'3"x17'9"

### COLOR





NEW



## ROUND ABOUT | PDWP-350036C32

Ages: 2-12  
 Fall Height: 72"  
 Use Zone: 62'x46'  
 Equipment Size: 49'7"x33'2"x13'

### COLOR

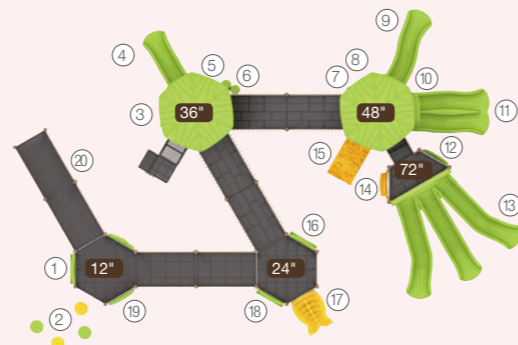

- ① World Map Panel
- ② Single Pebble
- ③ Gears Panel
- ④ 3ft Single Slide
- ⑤ Beads & Cups Panel
- ⑥ Bongo
- ⑦ Four In A Row Panel (Above)
- ⑧ Saddle Seat (Below)
- ⑨ 4ft Single Slide
- ⑩ Rain Wheel
- ⑪ 4ft Double Slide
- ⑫ Puzzle Panel
- ⑬ 6ft Triple Sectional Split Slide
- ⑭ Counter Panel
- ⑮ 4ft/5ft Rock Climber
- ⑯ Clear Panel
- ⑰ 2ft/3ft Fish Climber
- ⑱ ABC Panel
- ⑳ ADA Ramp



## TIMBERLAND | PDWP-350070C32

Ages: 2-12  
 Fall Height: 60"  
 Use Zone: 61'x45'  
 Equipment Size: 48'11"x32'x14'

### COLOR

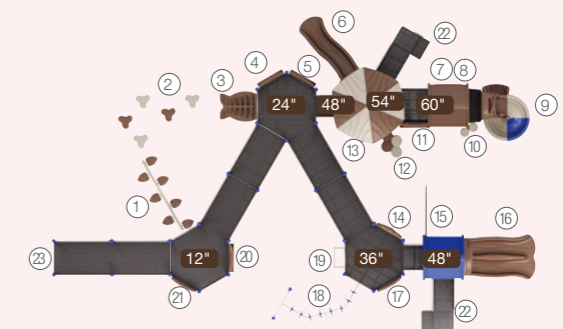

- ① Leaf Balance Beam
- ② 6" Clover Step
- ③ 2ft/3ft Fish Climber
- ④ Four In A Row Panel
- ⑤ Window Panel
- ⑥ 4ft Single Slide
- ⑦ Beads & Cups Panel
- ⑧ Saddle Seat
- ⑨ 8
- ⑩ Bongo
- ⑪ Gears Panel
- ⑫ 4ft Trunk Climber
- ⑬ ABC Panel
- ⑭ Safety Panel
- ⑮ Sail PE Climbing Panel
- ⑯ 4ft Double Slide
- ⑰ Puzzle Panel
- ⑱ 90° Overhead Swinging Rings
- ⑲ 3ft Straight Rung Climber
- ⑳ World Map Panel
- ㉑ Maze Panel
- ㉒ ADA Transfer Station
- ㉓ ADA Ramp





# WisePLAY Custom

WisePLAY Custom playgrounds are a great solution for organizations that want to enhance their facility with a play space that has a slightly smaller footprint than the standard, but has option to be custom designed. Our Custom structures come in a variety of color palette options and are artistically crafted with 3.5" posts. This allows the structure to be lighter, and more versatile. Here at Wisdom Playgrounds, we accommodate making high quality playgrounds packed full of activities, without sacrificing features such as safety and durability.



## BALI | PDWP-350029C32

Ages: 5-12

Fall Height: 72"

Use Zone: 55'x53'

Equipment Size: 42'8"x40'7"x15'

### COLOR

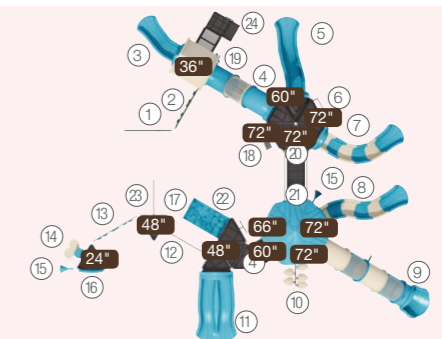

- ① Net Climber-Ladder
- ② Net Climber-Grass
- ③ 3ft Sectional Slide
- ④ Drum
- ⑤ 5ft Single Slide
- ⑥ 6ft Straight Rung Climber
- ⑦ 6ft Left Turn Sectional Slide
- ⑧ 6ft S Shape Sectional Slide
- ⑨ 6ft Tunnel Slide
- ⑩ 6ft Leaf Step Climber
- ⑪ 4ft Double Slide
- ⑫ Lateral Climbing Frame
- ⑬ Sail PE Climbing Panel
- ⑭ 2ft Truck Climber
- ⑮ Talk Tube
- ⑯ Beads & Cups Panel
- ⑰ 4ft/5ft Rock Climber
- ⑱ 6ft Wing Climber
- ⑲ Rain Wheel
- ⑳ Counter Panel (Below)
- ㉑ ABC Panel (Below)
- ㉒ 4ft Snake Climber
- ㉓ Stair Climber
- ㉔ ADA Transfer Station







## SUNDAZED | PDWP-350030C00

Ages: 5-12

Fall Height: 96"

Use Zone: 44'x51'

Equipment Size: 27'2"x36'8"x14'10"

### COLOR

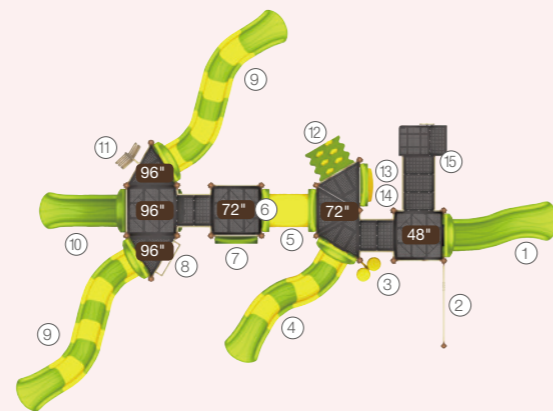

- ① 4ft Single Slide
- ② Net Climber-Ladder
- ③ Bongo
- ④ 6ft S Shape Sectional Slide
- ⑤ 31" Crawl Tunnel
- ⑥ Beads & Cups Panel (Below)
- ⑦ World Map Panel
- ⑧ 8ft Straight Rung Climber
- ⑨ 8ft S Shape Sectional Slide
- ⑩ 3ft Single Slide
- ⑪ 8ft Wing Climber
- ⑫ 6ft PE Rock Climber
- ⑬ Gears Panel (Above)
- ⑭ Counter Panel (Below)
- ⑮ ADA Transfer Station



## PINNWHEEL PARADE | PDWP-350031C32

Ages: 5-12

Fall Height: 84"

Use Zone: 45'x42'

Equipment Size: 32'9"x29'2"x14'5"

### COLOR

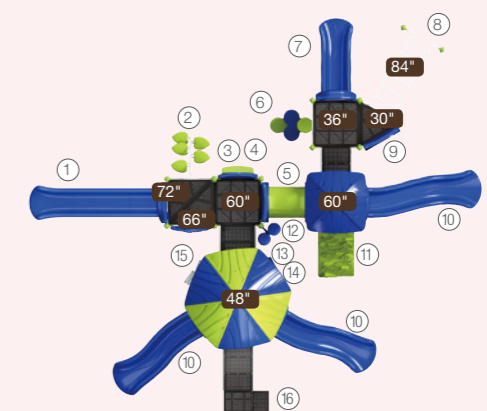

- ① 6ft Single Slide
- ② 6ft Leaf Step Climber
- ③ Counter Panel (Below)
- ④ Maze Panel (Above)
- ⑤ 31" Crawl Tunnel
- ⑥ 3ft Trunk Climber
- ⑦ 3ft Single Slide
- ⑧ Challenge Ladder
- ⑨ World Map Panel
- ⑩ 5ft Single Slide
- ⑪ 4ft/5ft Rock Climber
- ⑫ Bongo
- ⑬ Gears Panel (Above)
- ⑭ Saddle Seat (Below)
- ⑮ 4ft Wing Climber
- ⑯ ADA Transfer Station







## PARADISE | PDWP-350032C32

Ages: 5-12  
 Fall Height: 84"  
 Use Zone: 34'x46'  
 Equipment Size: 21'6"x33'4"x13'9"

### COLOR

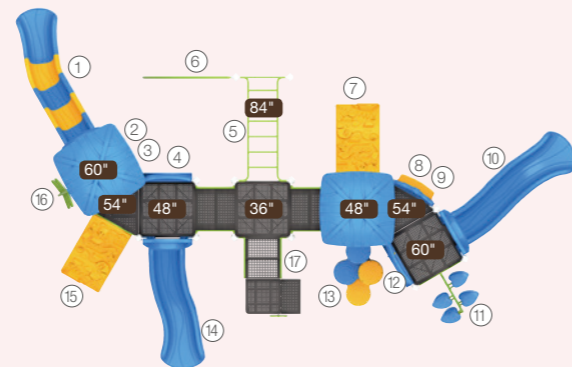

- ① 5ft Sectional Slide Left Turn
- ② Beads & Cups Panel (Above)
- ③ Saddle Seat (Below)
- ④ Four In A Row Panel
- ⑤ Challenge Ladder
- ⑥ Sail PE Climbing Panel
- ⑦ 4ft/5ft Rock Climber
- ⑧ Safety Panel (Above)
- ⑨ Counter Panel (Below)
- ⑩ 5ft Single Slide
- ⑪ 5ft Leaf Step Climber
- ⑫ Gears Panel
- ⑬ 4ft Trunk Climber
- ⑭ 4ft Single Slide
- ⑮ 4ft/5ft Rock Climber
- ⑯ 5ft Wing Climber
- ⑰ ADA Transfer Station



## MCCALL | PDWP-350033C15

Ages: 5-12  
 Fall Height: 72"  
 Use Zone: 56'x31'  
 Equipment Size: 43'3"x18'5"x14'5"

### COLOR

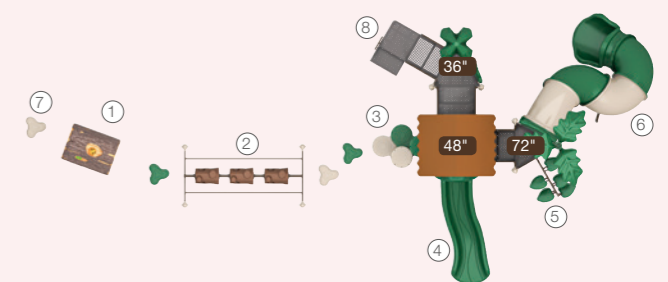

- ① GFRC Timber Crawl Tunnel
- ② Balance Stumps Bridge W/Single Handrail
- ③ 4ft Trunk Climber
- ④ 4ft Single Slide
- ⑤ 6ft Leaf Step Climber
- ⑥ 6ft Spiral Tube Slide
- ⑦ Frog Hopper
- ⑧ ADA Transfer Station





## GOLDSTAR | PDWP-350034C00

Ages: 5-12  
 Fall Height: 96"  
 Use Zone: 38'x33'  
 Equipment Size: 23'7"x19'x12'7"

### COLOR

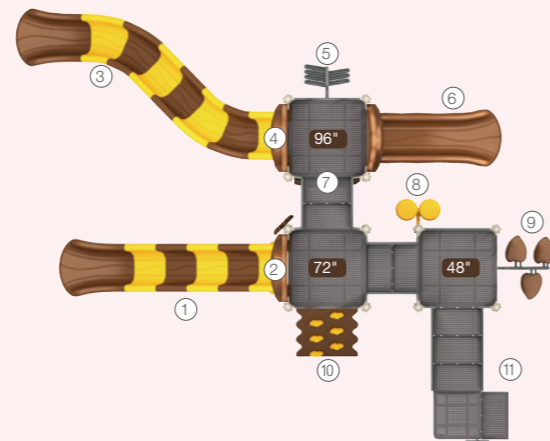

- ① 6ft Sectional Slide
- ② Counter Panel (Below)
- ③ 8ft S Shape Sectional Slide
- ④ 3ft PE Rock Climber (Below)
- ⑤ 8ft Wing Climber
- ⑥ 3ft Single Slide
- ⑦ Maze Panel (Below)
- ⑧ Bongo
- ⑨ 4ft Leaf Step Climber
- ⑩ 6ft PE Rock Climber
- ⑪ ADA Transfer Station



## FANTASTIC FUN | PDWP-350035C00

Ages: 5-12  
 Fall Height: 60"  
 Use Zone: 35'x31'  
 Equipment Size: 22'2"x18'2"x10'

### COLOR

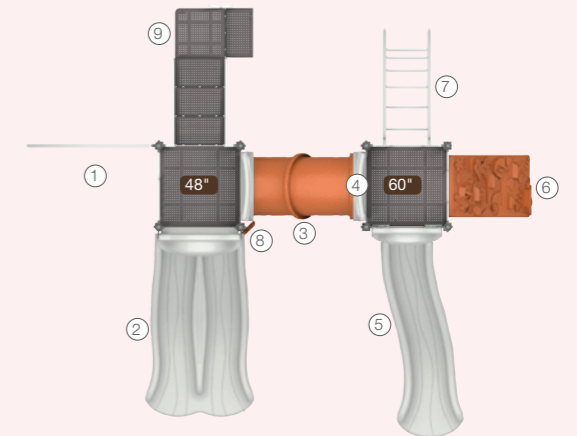

- ① Sail PE Climbing Panel
- ② 4ft Double Slide
- ③ Inclined Crawl Tunnel
- ④ Counter Panel (Below)
- ⑤ 5ft Single Slide
- ⑥ 4ft/5ft Rock Climber
- ⑦ 5ft Arch Climber
- ⑧ Rain Wheel
- ⑨ ADA Transfer Station





NEW



## CLIMB AND RIDE | PDWP-350076C00

Ages: 5-12  
 Fall Height: 84"  
 Use Zone: 52'x40'  
 Equipment Size: 39'8"x27'6"x10'1"

### COLOR

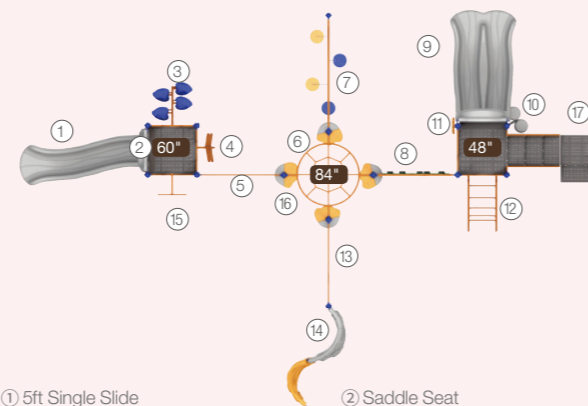

- ① 5ft Single Slide
- ② Saddle Seat
- ③ 5ft Leaf Step Climber
- ④ 5ft Wing Climber
- ⑤ Vertical Net Link
- ⑥ Overhead Challenger
- ⑦ Swing Discs
- ⑧ Net Climber-Grass & Ladybug
- ⑨ 4ft Double Slide
- ⑩ Bongo
- ⑪ Rain Wheel
- ⑫ 4ft Arch Climber
- ⑬ Power Rungs
- ⑭ Vertical Rock Climber
- ⑮ 5ft Snake Climber
- ⑯ Bear Step
- ⑰ ADA Transfer Station

NEW



## ANASTASIA | PDWP-350081C32

Ages: 5-12  
 Fall Height: 96"  
 Use Zone: 40'x43'  
 Equipment Size: 27'2"x28'4"x16'2"

### COLOR

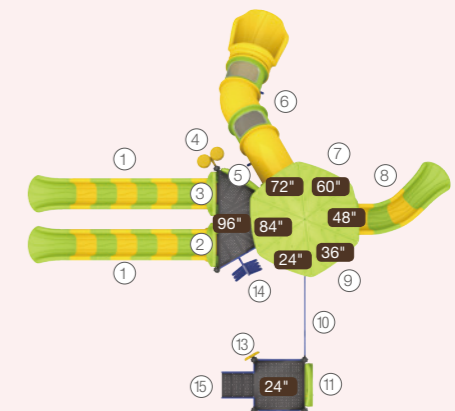

- ① 8ft Sectional Slide
- ② Counter Panel
- ③ Red Window Panel
- ④ Bongo
- ⑤ Beads & Cups Panel
- ⑥ 6ft L-shape Tube Slide Right Turn
- ⑦ 5ft Upright PE Rock Climber
- ⑧ 4ft Sectional Slide 45° Left Turn
- ⑨ 3ft Upright PE Rock Climber
- ⑩ Rung Challenge Climber
- ⑪ Gears Panel
- ⑫ 2ft Upright PE Rock Climber
- ⑬ Rain Wheel
- ⑭ 8ft Wing Climber
- ⑮ ADA Transfer Station



NEW



## ARIEL | PDWP-350078C00

Ages: 5-12  
 Fall Height: 72"  
 Use Zone: 51'x34'  
 Equipment Size: 38'9"x21'5"x11'

### COLOR

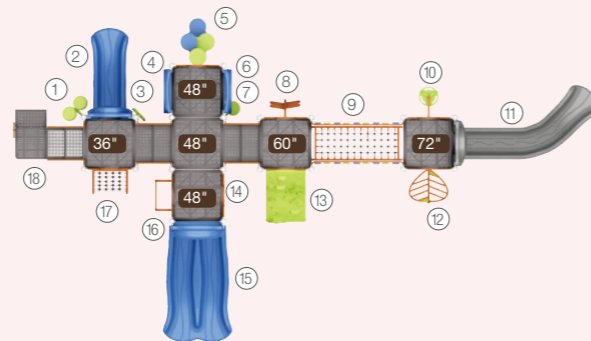

- ① Bongo
- ② 3ft Single Slide
- ③ Rain Wheel
- ④ World Map Panel
- ⑤ 4ft Trunk Climber
- ⑥ Gears Panel
- ⑦ PE Stool
- ⑧ 5ft Wing Climber
- ⑨ Inclined Arch Net Bridge
- ⑩ 6ft Pod Climber
- ⑪ 6ft Sectional Slide 45° Left Turn
- ⑫ 6ft Leaf Climber
- ⑬ 4ft/5ft Rock Climber
- ⑭ 4ft GEO Vertical Climber
- ⑮ 4ft Double Slide
- ⑯ 4ft Straight Rung Climber
- ⑰ Frankfurt - 3ft Net Climber
- ⑱ ADA Transfer Station



NEW



## DARWINS | PDWP-350079C32

Ages: 5-12  
 Fall Height: 72"  
 Use Zone: 51'x42'  
 Equipment Size: 38'1"x29'9"x14'4"

### COLOR

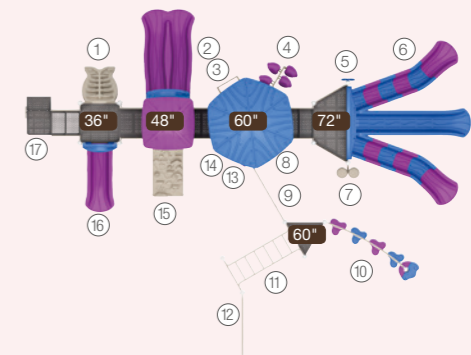

- ① 2ft/3ft Fish Climber
- ② 4ft Double Slide
- ③ Challenge Ladder
- ④ 5ft Leaf Step Climber
- ⑤ Rain Wheel
- ⑥ 6ft Triple Sectional Split Slide
- ⑦ Bongo
- ⑧ 5ft Upright PE Rock Climber
- ⑨ Rung Challenge Climber
- ⑩ 4 Clover Steps Bridge
- ⑪ 5ft Straight Rung Climber
- ⑫ Sail PE Climbing Panel
- ⑬ Gears Panel (Above)
- ⑭ Saddle Seat (Below)
- ⑮ 4ft/5ft Rock Climber
- ⑯ ADA Transfer Station
- ⑰ 3ft Single Slide





NEW



## FINSTER | PDWP-350080C11

Ages: 5-12  
 Fall Height: 60"  
 Use Zone: 30'x38'  
 Equipment Size: 17'11"x25'11"x13'10"

### COLOR

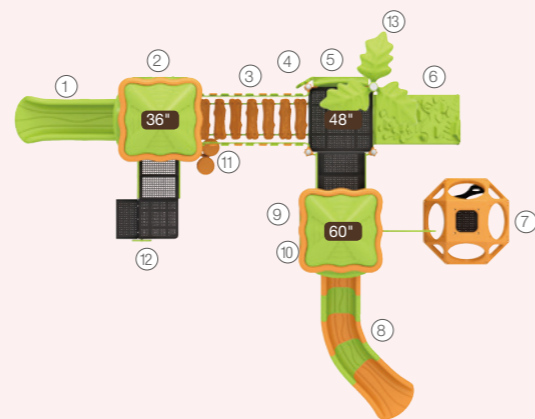

- ① 3ft Single Slide
- ② Gears Panel
- ③ Inclined Arch Net Bridge
- ④ Rain Wheel
- ⑤ World Map Panel
- ⑥ 4ft/5ft Rock Climber
- ⑦ Qubest
- ⑧ 5ft Sectional Slide 45° Left Turn
- ⑨ Beads & Cups Panel (Above)
- ⑩ Saddle Seat (Below)
- ⑪ Bongo
- ⑫ ADA Transfer Station
- ⑬ Palm Topper



NEW



## TWISTER | PDWP-350077C15

Ages: 5-12  
 Fall Height: 108"  
 Use Zone: 40'x34'  
 Equipment Size: 27'3"x22'x14'9"

### COLOR

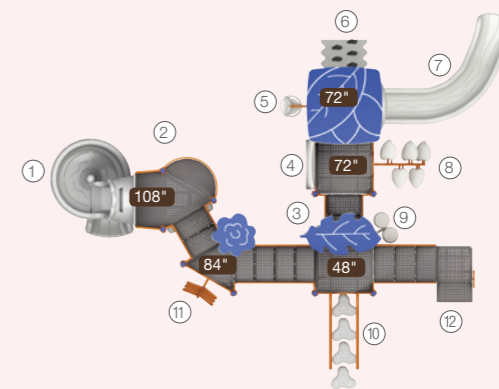

- ① 9ft Spiral Slide
- ② Saddle Seat
- ③ Rain Wheel
- ④ ABC Panel
- ⑤ 6ft Pod Climber
- ⑥ 6ft PE Rock Climber
- ⑦ 6ft Sectional Slide 67.5° Left Turn
- ⑧ 6ft Leaf Step Climber
- ⑨ Bongo
- ⑩ 4ft Clover Steps
- ⑪ 7ft Wing Climber
- ⑫ ADA Transfer Station





NEW



## JUNGLE GEM | PDWP-350082C32

Ages: 5-12  
 Fall Height: 96"  
 Use Zone: 43'x36'  
 Equipment Size: 28'10"x23'7"x17'1"

### COLOR

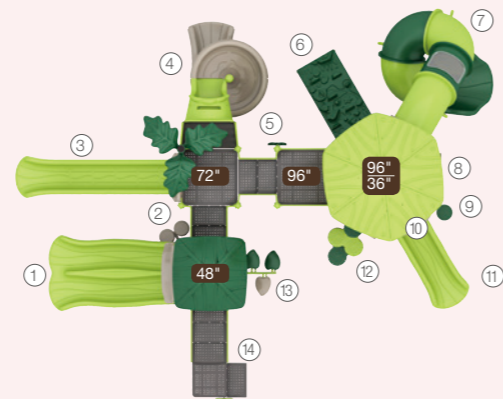

- ① 4ft Double Slide
- ② Bongo
- ③ 6ft Sectional Slide
- ④ 4ft Spiral Slide
- ⑤ Rain Wheel
- ⑥ 4ft/5ft Rock Climber
- ⑦ 8ft Spiral Tube Slide Right Turn
- ⑧ ABC Panel
- ⑨ PE Stool
- ⑩ Beads & Cups Panel (Above)
- ⑪ 3ft Single Slide
- ⑫ 3ft Trunk Climber
- ⑬ 4ft Leaf Step Climber
- ⑭ ADA Transfer Station

NEW



## ROVER RIDER | PDWP-350083C00

Ages: 5-12  
 Fall Height: 72"  
 Use Zone: 41'x38'  
 Equipment Size: 28'3"x25'8"x10'

### COLOR

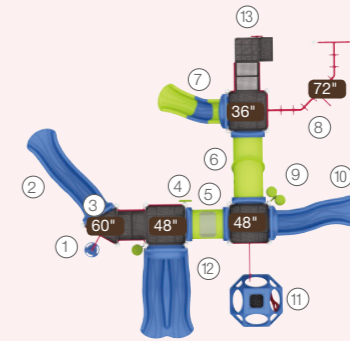

- ① 5ft Pod Climber
- ② 5ft Single Slide
- ③ Counter Panel (Below)
- ④ Rain Wheel
- ⑤ Crawl Tunnel
- ⑥ Inclined Crawl Tunnel
- ⑦ 3ft Sectional Slide Right Turn
- ⑧ 90° Overhead Swinging Rings
- ⑨ Bongo
- ⑩ 4ft Single Slide
- ⑪ Qubest
- ⑫ 4ft Double Slide
- ⑬ ADA Transfer Station

## WHIRLIEWORLD | PDWP-350084C00

Ages: 5-12  
 Fall Height: 108"  
 Use Zone: 30'x32'  
 Equipment Size: 17'4"x17'8"x13'5"

### COLOR

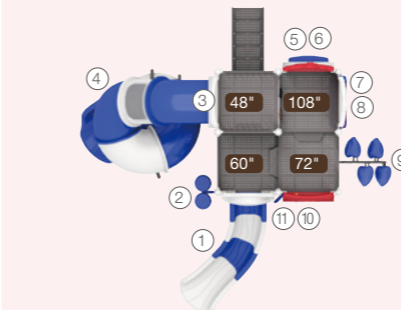

- ① 4ft Sectional Slide 45° Right Turn
- ② Bongo
- ③ Puzzle Panel (Below)
- ④ 9ft Spiral Tube Slide Left Turn
- ⑤ World Map Panel
- ⑥ Counter Panel
- ⑦ Beads & Cups Panel
- ⑧ Saddle Seat
- ⑨ 5ft Leaf Step Climber
- ⑩ Gears Panel
- ⑪ Rain Wheel



NEW





NEW



## BRISK SEABREEZE | PDWP-350085C32

Ages: 5-12  
 Fall Height: 72"  
 Use Zone: 36'x34'  
 Equipment Size: 24'x21'6"x15'1"

### COLOR

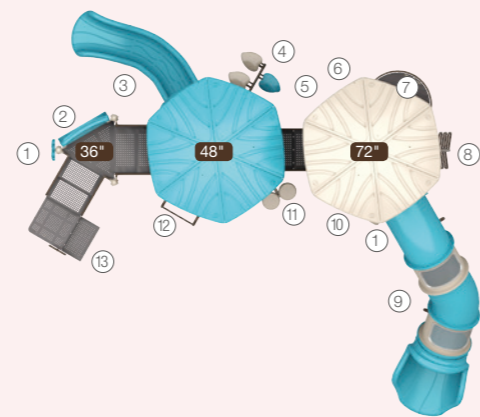

- ① Rain Wheel
- ② World Map Panel
- ③ 4ft Sectional Slide 45° Left Turn
- ④ 4ft Leaf Step Climber
- ⑤ Maze Panel (Above)
- ⑥ Saddle Seat (Below)
- ⑦ Balcony Deck
- ⑧ 6ft Wing Climber
- ⑨ 6ft L-shape Tube Slide Right Turn
- ⑩ Puzzle Panel
- ⑪ Bongo
- ⑫ 4ft Straight Rung Climber
- ⑬ ADA Transfer Station

NEW



## DREAMLAND | PDWP-350086C13

Ages: 5-12  
 Fall Height: 96"  
 Use Zone: 43'x47'  
 Equipment Size: 30'2"x32'8"x20'8"

### COLOR

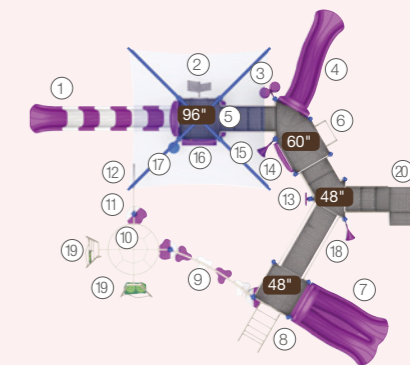

- ① 8ft Sectional Slide
- ② 8ft Wing Climber
- ③ Bongo
- ④ 5ft Single Slide
- ⑤ Saddle Seat
- ⑥ 5ft Straight Rung Climber
- ⑦ 4ft Double Slide
- ⑧ 4ft Arch Climber
- ⑨ 4 Clover Steps Bridge
- ⑩ Overhead Challenger
- ⑪ Bear Step
- ⑫ Treasure Hunt Panel
- ⑬ Rain Wheel
- ⑭ Puzzle Panel
- ⑮ Talk Tube
- ⑯ Gears Panel
- ⑰ PE Stool
- ⑱ Arch Bridge w/o Handrails
- ⑳ ADA Transfer Station



NEW



## AUTUMN | PDWP-350087C00

Ages: 5-12  
 Fall Height: 48"  
 Use Zone: 33'x30'  
 Equipment Size: 20'5" x 17'9" x 9'1"

### COLOR

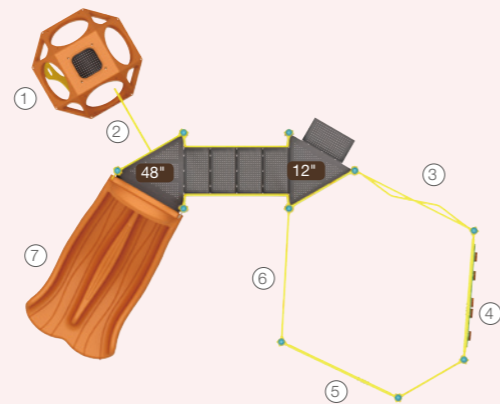

- ① Qubest
- ② Qubest Climber Entry
- ③ S Balance Bridge
- ④ Net Climber-Grass & Ladybug
- ⑤ Net Climber-Ladder
- ⑥ Rung Challenge Climber
- ⑦ 4ft Double Slide



NEW



## AVONDALE | PDWP-350088C12

Ages: 5-12  
 Fall Height: 48"  
 Use Zone: 36'x25'  
 Equipment Size: 23'4" x 13' x 13'

### COLOR

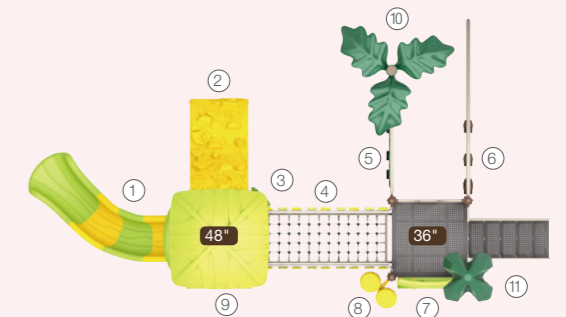

- ① 4ft Sectional Slide 45° Right Turn
- ② 4ft/5ft Rock Climber
- ③ Rain Wheel
- ④ Inclined Arch Net Bridge
- ⑤ Net Climber-Grass & Ladybug
- ⑥ Arch PE Crawl Panel
- ⑦ Gears Panel
- ⑧ Bongo
- ⑨ ABC Panel
- ⑩ Palm Topper
- ⑪ Pine Topper





NEW



## TERRYS MAZE | PDWP-350089C13

Ages: 5-12  
 Fall Height: 84"  
 Use Zone: 41'x40'  
 Equipment Size: 28'9"x26'1"x17'2"

### COLOR

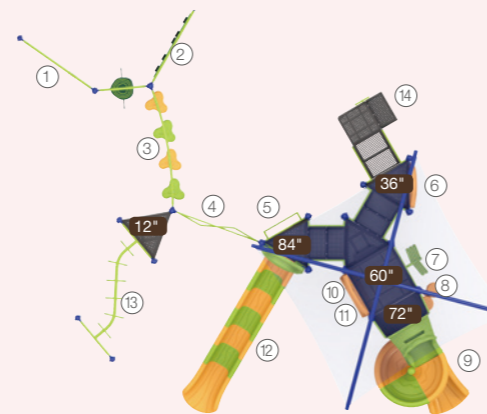

- ① Ladybug Ladder Climber
- ② Net Climber-Grass & Ladybug
- ③ 4 Clover Steps Bridge
- ④ S Balance Bridge
- ⑤ 7ft Straight Rung Climber
- ⑥ Puzzle Panel
- ⑦ 6ft Wing Climber
- ⑧ Bongo
- ⑨ 6ft Spiral Slide
- ⑩ Gears Panel (Above)
- ⑪ Saddle Seat (Below)
- ⑫ 7ft Sectional Slide
- ⑬ Zig Zag Overhead Rings
- ⑭ ADA Transfer Station

NEW



## LIGHTHOUSE | PDWP-350091C32

Ages: 5-12  
 Fall Height: 96"  
 Use Zone: 39'x37'  
 Equipment Size: 24'11"x22'7"x17'2"

### COLOR

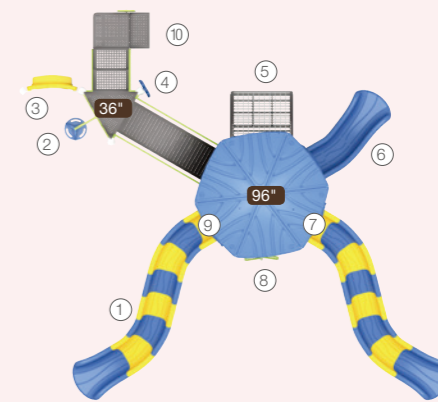

- ① 8ft S-shape Sectional Slide
- ② 3ft Pod Climber
- ③ Counter Panel
- ④ Rain Wheel
- ⑤ Arch Climbing Structure Bay Window
- ⑥ 3ft Sectional Slide Left Turn
- ⑦ World Map Panel
- ⑧ 3ft Wing Climber
- ⑨ ABC Panel (Below)
- ⑩ ADA Transfer Station



NEW



## EBULLIENCE | PDWP-350094C32

Ages: 5-12  
 Fall Height: 72"  
 Use Zone: 34'x35'  
 Equipment Size: 21'4"x22'3"x15'3"

### COLOR

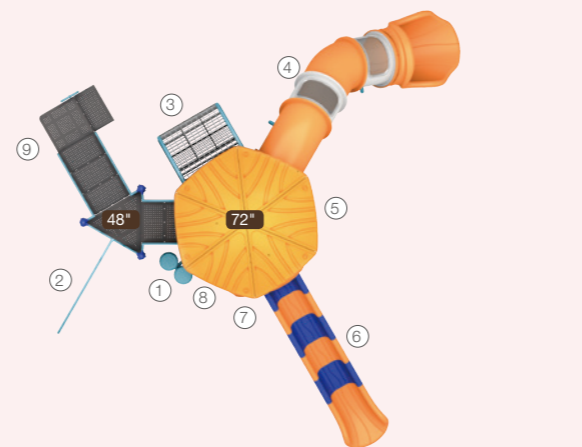

- ① Bongo
- ② Arch Climbing Structure Bay Window
- ③ 4ft Climbing Arch
- ④ 6ft L-shape Tube Slide Right Turn
- ⑤ 6ft GEO Vertical Climber
- ⑥ 6ft Sectional Slide
- ⑦ Rain Wheel
- ⑧ Gears Panel
- ⑨ ADA Transfer Station



NEW



## AMBERLEY | PDWP-350092C00

Ages: 5-12  
 Fall Height: 60"  
 Use Zone: 38'x37'  
 Equipment Size: 25'7"x24'9"x10'

### COLOR

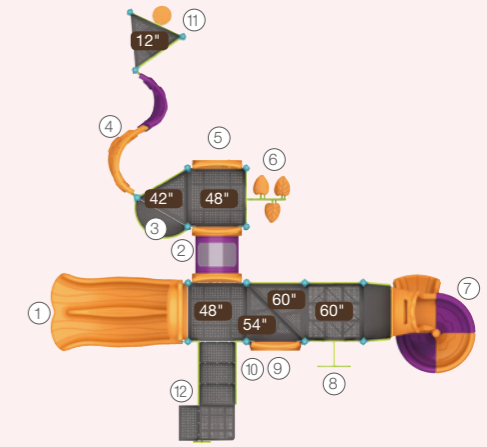

- ① 4ft Double Slide
- ② Crawl Tunnel
- ③ Balcony Deck
- ④ Vertical Rock Climber
- ⑤ Gears Panel
- ⑥ 4ft Leaf Step Climber
- ⑦ 2ft Spiral Slide
- ⑧ 5ft Snake Climber
- ⑨ ABC Panel
- ⑩ Saddle Seat
- ⑪ 12" Single Trunk Climber
- ⑫ ADA Transfer Station





NEW

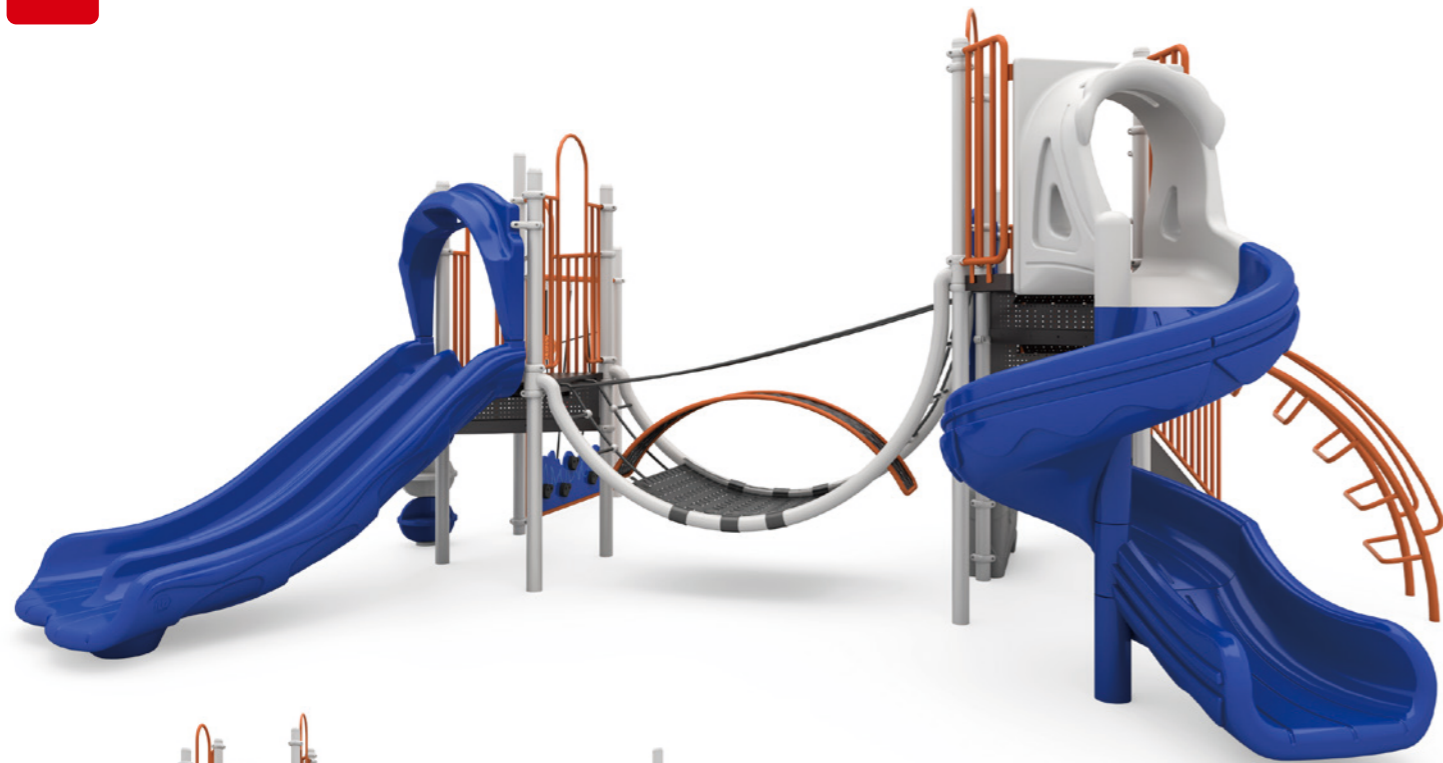

## RIALTO | PDWP-350093C00

Ages: 5-12  
 Fall Height: 60"  
 Use Zone: 35'x30'  
 Equipment Size: 22'11"x17'11"x10'10"

### COLOR

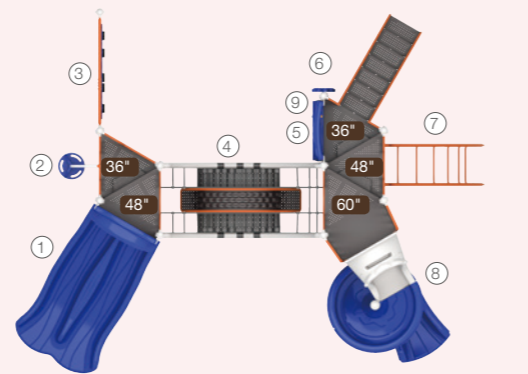

- ① 4ft Double Slide
- ② 3ft Pod Climber
- ③ Net Climber-Grass & Ladybug
- ④ Beachcomber Structure
- ⑤ Gears Panel
- ⑥ Rain Wheel
- ⑦ 5ft Arch Climber
- ⑧ 2ft Spiral Slide
- ⑨ Saddle Seat (Below)



## SALMON | PDWP-350039C32

Ages: 2-5  
 Fall Height: 48"  
 Use Zone: 40'x37'  
 Equipment Size: 27'11"x24'4"x13'2"

### COLOR

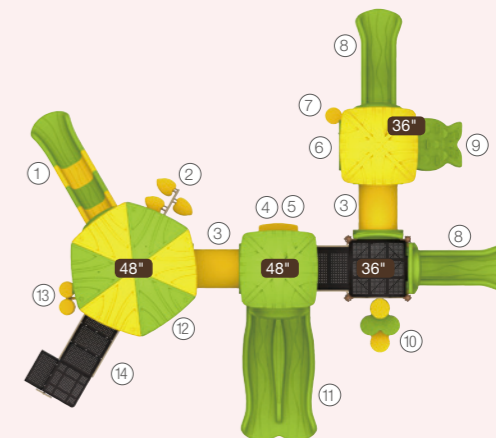

- ① 4ft Single Slide
- ② 4ft Leaf Step Climber
- ③ 31" Crawl Tunnel
- ④ Counter Panel (Below)
- ⑤ Maze Panel
- ⑥ Gears Panel
- ⑦ PE Stool
- ⑧ 3ft Single Slide
- ⑨ 2ft/3ft Fish Climber
- ⑩ 3ft Trunk Climber
- ⑪ 4ft Double Slide
- ⑫ Puzzle Panel
- ⑬ Bongo
- ⑭ ADA Transfer Station





NEW



## KUZKO | PDWP-350095C12

Ages: 5-12

Fall Height: 96"

Use Zone: 34'x50'

Equipment Size: 21'11"x35'3"x14'9"

### COLOR

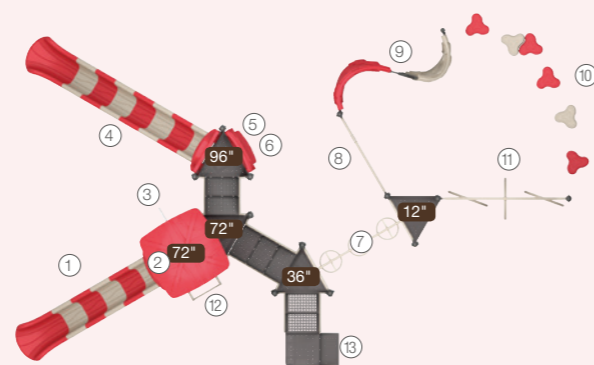

- ① 6ft Sectional Slide
- ② Saddle Seat
- ③ 6ft Fireman's Pole
- ④ 8ft Sectional Slide
- ⑤ Window Panel
- ⑥ Counter Panel
- ⑦ Overhead Rotating Rings
- ⑧ Net Climber-Ladder
- ⑨ Vertical Rock Climber
- ⑩ 12" Clover Step
- ⑪ Lilly Pad Walk
- ⑫ 6ft Straight Rung Climber
- ⑬ ADA Transfer Station



NEW



## MOWGI | PDWP-350096C32

Ages: 5-12

Fall Height: 72"

Use Zone: 46'x38'

Equipment Size: 33'2"x25'9"x13'10"

### COLOR

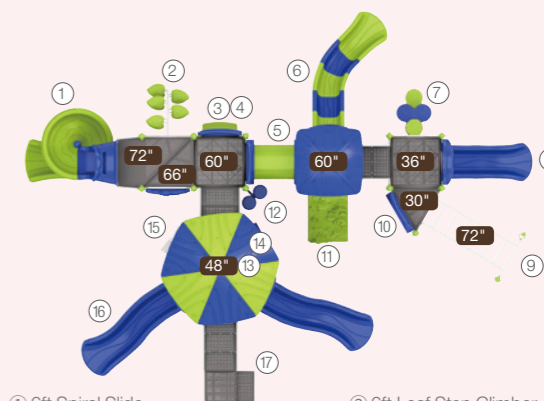

- ① 6ft Spiral Slide
- ② 6ft Leaf Step Climber
- ③ Maze Panel
- ④ Counter Panel
- ⑤ 31" Crawl Tunnel
- ⑥ 5ft Sectional Slide 45° Right Turn
- ⑦ 3ft Trunk Climber
- ⑧ 3ft Single Slide
- ⑨ Challenge Ladder
- ⑩ World Map Panel
- ⑪ 4ft/5ft Rock Climber
- ⑫ Bongo
- ⑬ Gears Panel
- ⑭ Saddle Seat
- ⑮ 4ft Wing Climber
- ⑯ 4ft Single Slide
- ⑰ ADA Transfer Station





NEW



## LILLY PAD | WPPE-350002C13

Ages: 5-12  
 Fall Height: 96"  
 Use Zone: 39'x40'  
 Equipment Size: 26'10"x25'5"x17'5"

### COLOR

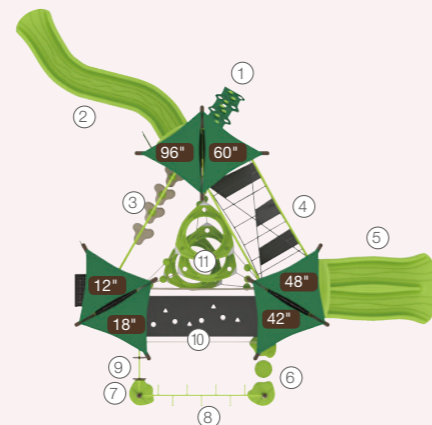

- ① 5ft PE Rock Climber
- ② 8ft S-shape Sectional Slide
- ③ 3ft Vertical PE Rock Climber
- ④ Belt Climber
- ⑤ 4ft Double Slide
- ⑥ 12" Single Trunk Climber
- ⑦ Bear Step
- ⑧ Straight Horizontal Lollipop Ladder
- ⑨ Straight Horizontal Loop Ladder
- ⑩ Inclined Elastic Bridge
- ⑪ Vertical O-zone Climber



NEW



## TREBLE LEAF | WPPE-350001C15

Ages: 2-5  
 Fall Height: 36"  
 Use Zone: 31'x25'  
 Equipment Size: 18'9"x12'1"x12'2"

### COLOR



- ① 3ft Sectional Slide Right Turn
- ② Game Table
- ③ Rope Ladder
- ④ Inclined Crawl Tunnel Section Right Turn
- ⑤ Bongo
- ⑥ H60 Arch Grab Climber
- ⑦ Leaf Table
- ⑧ Music Panel
- ⑨ Growth Ring Stool





# WisePLAY Theme

WisePLAY Theme uses themed based play components that give you the opportunity to create playgrounds that mimic components from children's wildest dreams. Our pirate ships, Tree Houses, and Castles transport children to far away lands. Designed with many components for long-lasting fun. With their large supports, broad platforms, and wide array of colors any of the WisePLAY Theme components are a great addition to parks, schools, and communities. The time tested materials sourced form and combined with the skilled craftsmanship at the factory, this equipment is durable and requires less maintenance over time.

WisePLAY Theme structures are built with 3.5" posts instead of 5" posts, which allows the structure to be lighter, and more versatile. Without sacrificing features such as safety or durability, we accommodate getting you a high quality playgrounds packed full of activities.



WisePLAY Castle

**NEW**



## WISE KINGDOM | BS35CS-0001

Ages: 2-12

Fall Height: 96"

Use Zone: 51'x54'

Equipment Size: 38'7"x41'5"x22'1"

### COLOR

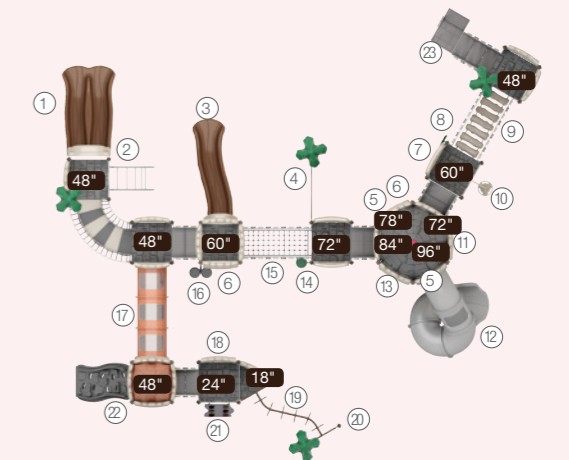

- ① 4ft Double Slide
- ② 4ft Arch Climber
- ③ 5ft Single Slide
- ④ Rung Challenge Climber
- ⑤ Visual Effects Panel (Below)
- ⑥ Clock Panel
- ⑦ World Map Panel
- ⑧ Rain Wheel
- ⑨ Step Board Bridge
- ⑩ 5ft Pod Climber
- ⑪ Four In A Row Panel
- ⑫ 8ft Spiral Tube Slide
- ⑬ Sand Clock Panel
- ⑭ PE Stool
- ⑮ Arch Net Bridge
- ⑯ Bongo
- ⑰ Crawl Tunnel
- ⑱ Counter Panel
- ⑲ Zig Zag Overhead Rings
- ⑳ Entry Ladder
- ㉑ 2ft PE Wave Rock Climber
- ㉒ 4ft/5ft Wave Climber
- ㉓ ADA Transfer Station





## ARTHER | BS35CS-0003

Ages: 2-12  
 Fall Height: 84"  
 Use Zone: 37'x38'  
 Equipment Size: 24'9"x24'9"x22'3"

- ① 5ft Single Slide
- ② 5ft Net Climber
- ③ 7ft Tube Slide
- ④ Sand Clock Panel
- ⑤ Bongo
- ⑥ Gears Panel
- ⑦ S Balance Bridge
- ⑧ Rain Wheel
- ⑨ Arch Net Bridge
- ⑩ 4ft Net Climber
- ⑪ 4ft Double Slide
- ⑫ Clock Panel (Above)
- ⑬ Visual Effects Panel (Below)
- ⑭ ADA Transfer Station
- ⑮ Pine Topper

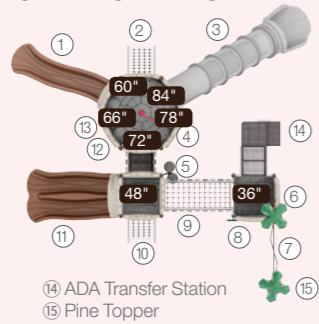

## CHAMELOT | BS35CS-0006

Ages: 2-12  
 Fall Height: 84"  
 Use Zone: 34'x29'  
 Equipment Size: 21'9"x16'4"x19'4"

- ① Entry Ladder
- ② Overhead Rotating Rings
- ③ Sand Clock Panel
- ④ Bongo
- ⑤ PE Stool
- ⑥ 4ft Double Slide
- ⑦ 4ft Pod Climber
- ⑧ 5ft Single Slide
- ⑨ Four In A Row Panel (Below)
- ⑩ Visual Effects Panel
- ⑪ ADA Transfer Station
- ⑫ Pine Topper

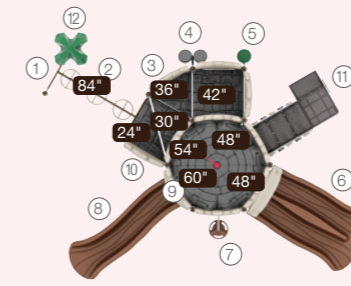

## ASLAN | BS35CS-0007

Ages: 2-12  
 Fall Height: 72"  
 Use Zone: 23'x49'  
 Equipment Size: 10'5"x36'1"x16'4"

- ① 6ft Sectional Slide
- ② Counter Panel (Below)
- ③ Sand Clock Panel
- ④ Arch Net Bridge
- ⑤ 4ft Single Slide
- ⑥ Saddle Seat (Below)
- ⑦ 4ft Arch Climber
- ⑧ Visual Effects Panel
- ⑨ ADA Transfer Station
- ⑩ Pine Topper

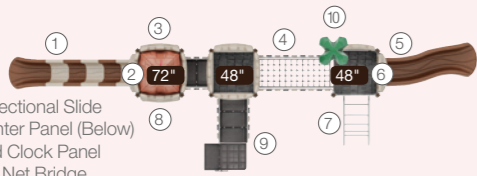

## CHARLES | BS35CS-0008

Ages: 2-12  
 Fall Height: 84"  
 Use Zone: 41'x28'  
 Equipment Size: 28'5"x15'8"x15'1"

- ① Bongo
- ② 4ft Pod Climber
- ③ Saddle Seat
- ④ 5ft Single Slide
- ⑤ Rain Wheel
- ⑥ Sand Clock Panel
- ⑦ 4ft Double Slide
- ⑧ Gears Panel
- ⑨ Entry Ladder
- ⑩ Overhead Rotating Rings
- ⑪ Visual Effects Panel
- ⑫ ADA Transfer Station
- ⑬ Pine Topper

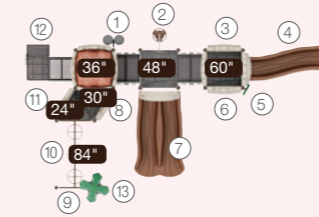

## LOUIS | BS35CS-0009

Ages: 2-5  
 Fall Height: 48"  
 Use Zone: 38'x28'  
 Equipment Size: 25'26"x15'4"x18'4"

- ① 4ft Single Slide
- ② Saddle Seat (Below)
- ③ Arch Net Bridge
- ④ 3ft Single Slide
- ⑤ Gears Panel
- ⑥ Rain Wheel
- ⑦ 4ft Arch Climber
- ⑧ Sand Clock Panel
- ⑨ ADA Transfer Station
- ⑩ Pine Topper

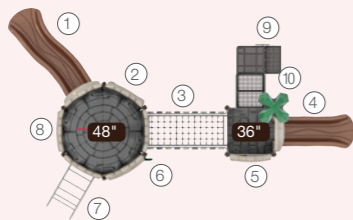

## RICHARD | BS35CS-0010

Ages: 2-5  
 Fall Height: 48"  
 Use Zone: 31'x24'  
 Equipment Size: 19'x11'9"x13'1"

- ① Gears Panel
- ② 4ft/5ft Wave Climber
- ③ 4ft Single Slide
- ④ Saddle Seat
- ⑤ ADA Transfer Station
- ⑥ Pine Topper

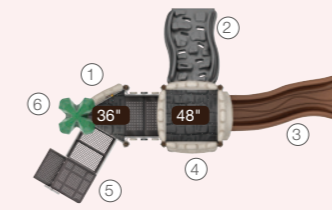



NEW



## WisePLAY Treehouse



NEW

### AMAZON FOREST | BS35TH-0001

Ages: 5-12  
 Fall Height: 84"  
 Use Zone: 56'x52'  
 Equipment Size: 43'7"x39'7"x16'2"

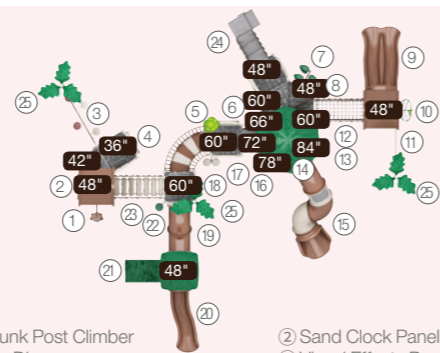

#### COLOR



- ① 4ft Trunk Post Climber
- ② Sand Clock Panels
- ③ Swing Discs
- ④ Visual Effects Panel
- ⑤ Rain Wheel
- ⑥ 4ft Upright Vertical Climber
- ⑦ 4ft Leaf Step Climber
- ⑧ Arch Net Bridge
- ⑨ 4ft Double Slide
- ⑩ 4ft Leaf Climber
- ⑪ Rung Challenge Climber
- ⑫ Puzzle Panel (Above)
- ⑬ Jungle Adventure Panel (Below)
- ⑭ Counter Panel
- ⑮ 7ft Spiral Tube Slide
- ⑯ ABC Panel
- ⑰ Bongo
- ⑱ S Shape Crawl Tunnel
- ⑲ 4ft/5ft Rock Climber
- ⑳ PE Stool
- ㉑ Step Board Bridge
- ㉒ ADA Transfer Station
- ㉓ Palm Topper



### MONTEVERDE | BS35TH-0002

Ages: 5-12  
 Fall Height: 96"  
 Use Zone: 46'x40'  
 Equipment Size: 33'5"x27'9"x17'2"

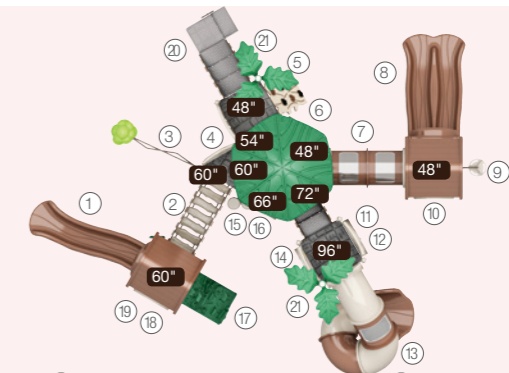

#### COLOR



- ① 5ft Single Slide
- ② Step Board Bridge
- ③ S Balance Bridge
- ④ Maze Panel
- ⑤ 4ft PE Trunk Rock Climber
- ⑥ World Map Panel
- ⑦ Crawl Tunnel
- ⑧ 4ft Double Slide
- ⑨ 4ft Pod Climber
- ⑩ Sand Clock Panel
- ⑪ Jungle Adventure Panel (Below)
- ⑫ Beads & Cups Panel (Above)
- ⑬ 8ft Spiral Tube Slide
- ⑭ Gears Panel
- ⑮ Bongo
- ⑯ Visual Effects Panel
- ⑰ 4ft/5ft Rock Climber
- ⑱ Four In A Row Panel (Above)
- ⑲ Saddle Seat (Below)
- ⑳ ADA Transfer Station
- ㉑ Palm Topper





## BORNEO | BS35TH-0003

Ages: 2-12  
 Fall Height: 96"  
 Use Zone: 42'x37'  
 Equipment Size: 27'4"x24'4"x17'2"

### COLOR

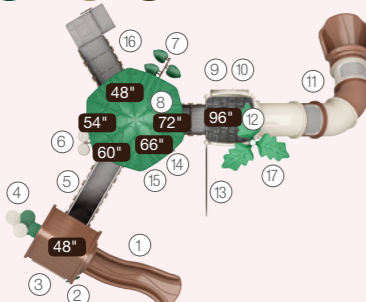

- ① 4ft Single Slide
- ② Rain Wheel
- ③ Sand Clock Panel
- ④ 4ft Trunk Climber
- ⑤ Straight Bridge
- ⑥ Bongo
- ⑦ 4ft Leaf Step Climber
- ⑧ Beads & Cups Panel
- ⑨ Puzzle Panel (Above)
- ⑩ Jungle Adventure Panel (Below)
- ⑪ 8ft Spiral Tube Slide
- ⑫ Counter Panel
- ⑬ Sail PE Climbing Panel
- ⑭ Visual Effects Panel (Above)
- ⑮ Saddle Seat (Below)
- ⑯ ADA Transfer Station
- ⑰ Palm Topper



## KIPLING | BS35TH-0004

Ages: 2-12  
 Fall Height: 48"  
 Use Zone: 48'x38'  
 Equipment Size: 35'2"x25'10"x13'5"

### COLOR

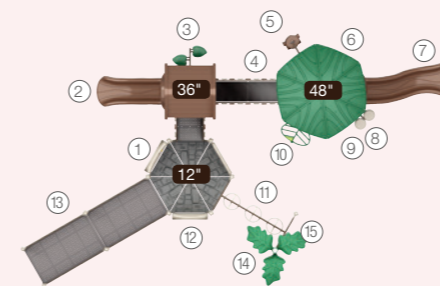

- ① Gears Panel
- ② 3ft Single Slide
- ③ 3ft Leaf Step Climber
- ④ Straight Bridge
- ⑤ 4ft Trunk Post Climber
- ⑥ Saddle Seat
- ⑦ 4ft Single Slide
- ⑧ Bongo
- ⑨ Maze Panel
- ⑩ 4ft Leaf Climber
- ⑪ Overhead Rotating Rings
- ⑫ Four In A Row Panel
- ⑬ ADA Ramp
- ⑭ Palm Topper
- ⑮ Entry Ladder



## SINHARAJA | BS35TH-0005

Ages: 2-5  
 Fall Height: 60"  
 Use Zone: 32'x39'  
 Equipment Size: 19'4"x26'11"x13'

### COLOR

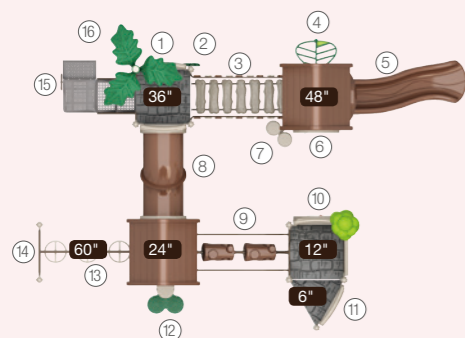

- ① Puzzle Panel
- ② Rain Wheel
- ③ Step Board Bridge
- ④ 4ft Leaf Climber
- ⑤ 4ft Single Slide
- ⑥ Gears Panel
- ⑦ Bongo
- ⑧ S Shape Crawl Tunnel
- ⑨ Trunk Link w/Handrail
- ⑩ Jungle Adventure Panel
- ⑪ Beads & Cups Panel
- ⑫ 2ft Trunk Climber
- ⑬ Overhead Rotating Rings
- ⑭ Entry Ladder
- ⑮ ADA Transfer Station
- ⑯ Palm Topper



## DAINTREE | BS35TH-0009

Ages: 2-12  
 Fall Height: 84"  
 Use Zone: 37'x33'  
 Equipment Size: 25'x20'11"x14'2"

### COLOR

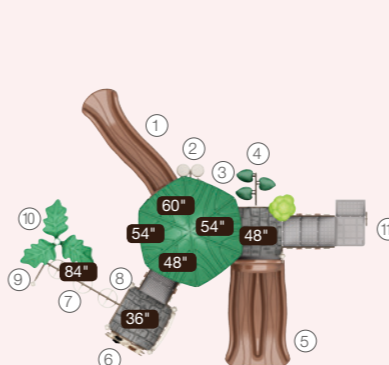

- ① 5ft Single Slide
- ② Bongo
- ③ ABC Panel
- ④ 4ft Leaf Climber
- ⑤ 4ft Double Slide
- ⑥ 3ft PE Trunk Rock Climber
- ⑦ Overhead Rotating Rings
- ⑧ Rain Wheel
- ⑨ Entry Ladder
- ⑩ Palm Topper
- ⑪ ADA Transfer Station







## WisePLAY Pirate Ship



### MEDITERRANEAN | BS35PS-0001

Ages: 5-12  
 Fall Height: 84"  
 Use Zone: 61'x48'  
 Equipment Size: 48'7"x35'1"x16'2"

#### COLOR

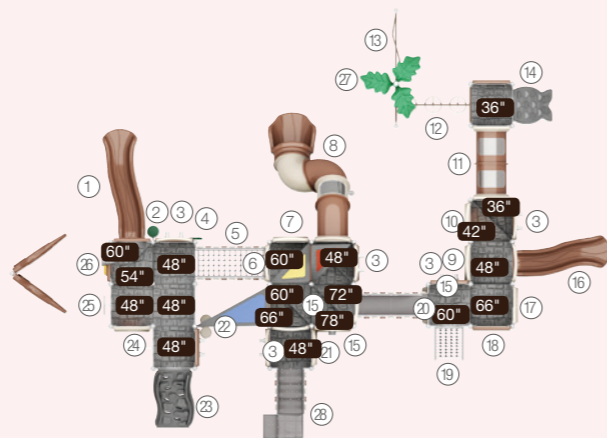

- |                                      |                           |
|--------------------------------------|---------------------------|
| ① 5ft Single Slide                   | ② PE Stool                |
| ③ Corsair Twin-barreled Cannon Panel | ④ Rain Wheel              |
| ⑤ Arch Net Bridge                    | ⑥ World Map Panel         |
| ⑦ Four In A Row Panel                | ⑧ 7ft S Tube Slide        |
| ⑨ ABC Panel                          | ⑩ Clear Window Panel      |
| ⑪ Crawl Tunnel                       | ⑫ Overhead Rotating Rings |
| ⑬ S Balance Bridge                   | ⑭ 2ft/3ft Fish Climber    |
| ⑮ Visual Effects Panel               | ⑯ 4ft Single Slide        |
| ⑰ Sand Clock Panel                   | ⑱ Decorative Panel        |
| ⑲ 5ft Net Climber                    | ⑳ Saddle Seat             |
| ㉑ Gears Panel                        | ㉒ Bongo                   |
| ㉓ Wave Rock Climber                  | ㉔ Clear Window Panel      |
| ㉕ 4ft Snake Climber                  | ㉖ Counter Panel           |
| ㉗ Palm Topper                        | ㉘ ADA Transfer Station    |



### SHREVEPORT | WPPE-350003C00

Ages: 2-12  
 Fall Height: 120"  
 Use Zone: 55'x46'  
 Equipment Size: 40'5"x33'5"x20'10"

#### COLOR

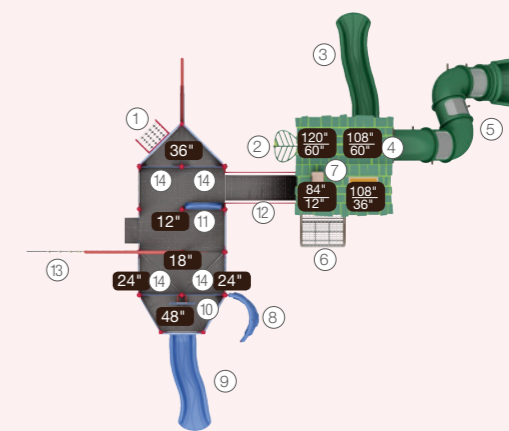

- |                                    |                                      |
|------------------------------------|--------------------------------------|
| ① 3ft Net Climber                  | ② 5ft Leaf Climber                   |
| ③ 5ft Single Slide                 | ④ Gears Panel                        |
| ⑤ 9ft S-shape Tube Slide Left Turn | ⑥ Arch Climbing Structure Bay Window |
| ⑦ Shed Roof w/Chimney              | ⑧ Vertical Rock Climber-L            |
| ⑨ 4ft Single Slide                 | ⑩ PE Fishing Boat Theme - Helm       |
| ⑪ STreasure Hunt Panel             | ⑫ Arch Bridge                        |
| ⑬ Sail Net Climber                 | ⑭ 2ft Upright PE Rock Climber        |





NEW



## SOUTHERN | BS35PS-0005

Ages: 2-5  
 Fall Height: 36"  
 Use Zone: 45'x26'  
 Equipment Size: 33'x13'9"x15'1"

### COLOR

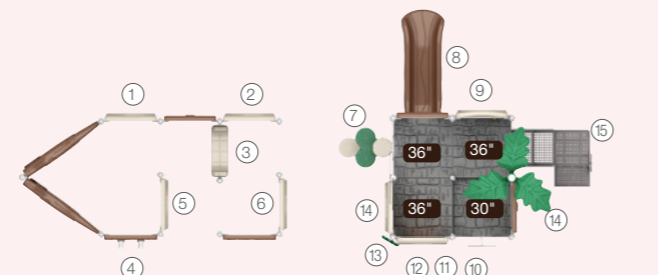

- ① ABC Panel
- ③ Saddle Seat
- ⑤ Visual Effects Panel
- ⑦ 3ft Trunk Climber
- ⑨ Gears Panel
- ⑪ Decorative Panel
- ⑬ Four In A Row Panel
- ⑮ ADA Transfer Station
- ② World Map Panel
- ④ Corsair Twin-barreled Cannon Panel
- ⑥ Sand Clock Panel
- ⑧ 3ft Single Slide
- ⑩ 3ft Snake Climber
- ⑫ Clear Window Panel
- ⑭ Palm Topper

NEW



## ARABIAN | BS35PS-0006

Ages: 2-5  
 Fall Height: 36"  
 Use Zone: 33'x29'  
 Equipment Size: 20'9"x16'10"x14'1"

### COLOR

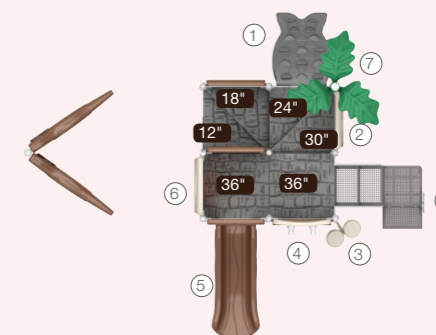

- ① 2ft/3ft Fish Climber
- ③ Bongo
- ⑤ 3ft Single Slide
- ⑦ Palm Topper
- ② Four In A Row Panel
- ④ Corsair Twin-barreled Cannon Panel
- ⑥ Clear Window Panel
- ⑧ ADA Transfer Station



# WiseMAX

WiseMAX systems are built with 5" posts instead of 3.5" posts, which means it can handle large end-user volumes without constricting the excitement and enthusiasm found in the flow of play.

The time-tested reliability of the materials sourced for and combined with the skilled craftsmanship at the factory, produces equipment that is durable and requires less maintenance over time, so that your play space remains fun, inviting and open to the public.

5.0

WM



- 167 WiseMAX Inclusive
- 169 WiseMAX Theme

[www.wisdomplaygrounds.com](http://www.wisdomplaygrounds.com)



# WiseMAX Inclusive

All-inclusive playgrounds are accessible, but not all accessible playgrounds are inclusive. At Wisdom Playgrounds we understand that we are not just designing our structures for the children. We know it takes a village to raise a child, which is why we always accommodate the parents and caregivers of various abilities that utilize our equipment. Following some fundamental principals, an inclusive playground will ensure that everyone can access the best play activities on the playground.

A crucial element to making an inclusive playground work for everyone is co-locating various kinds of the same type of activity so that someone who may have limited physical abilities can enjoy the same activity as the person close to them on a similar but perhaps more challenging activity. At Wisdom, we can all play together.

WiseMAX Inclusive playgrounds are artistically crafted with 5" OD galvanized steel support posts. Without sacrificing features such as safety or durability, we accommodate getting you a high quality playgrounds packed full of activities.



**NEW**



## IMAGINATION ZONE | AT50TH-0012

Ages: 5-12

Fall Height: 108"

Use Zone: 70'x40'

Equipment Size: 55'10"x28'x18'3"

### COLOR

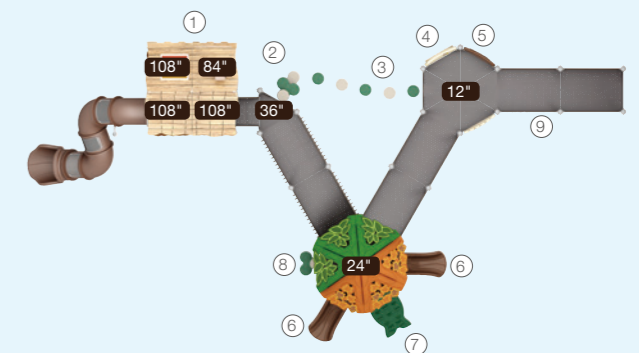

- ① Sky House
- ② 3ft Trunk Climber
- ③ 12" Single Trunk Climber
- ④ Gears Panel
- ⑤ Small Growth Ring & Clock Panel
- ⑥ 2ft Sectional Slide
- ⑦ 2ft/3ft Fish Climber
- ⑧ 2ft Trunk Climber
- ⑨ ADA Ramp



# WiseMAX Theme

WiseMAX Theme uses themed based play components that give you the opportunity to create playgrounds that mimic components from children's wildest dreams. Our pirate ships, Tree Houses, and Castles transport children to far away lands. Designed with many components for long-lasting fun. With their large supports, broad platforms, and wide array of colors any of the WisePLAY Theme components are a great addition to parks, schools, and communities.

The time tested materials sourced from and combined with the skilled craftsmanship at the factory, this equipment is durable and requires less maintenance over time.

WiseMAX Theme structures are built with 5" posts, which means they can handle end-user volumes without constricting the excitement and enthusiasm found in the flow of play. The time-tested reliability of the materials sourced for and combined with the skilled craftsmanship at the factory, produces equipment that is durable and requires less maintenance over time, so that your play space remains fun, inviting and open to the public



**WiseMAX**  
**Treehouse**



## TREE TOP PARADISE | AT50TH-0001

Ages: 5-12

Fall Height: 120"

Use Zone: 63'x47'

Equipment Size: 51'10" x 32'9" x 20'11"

### COLOR

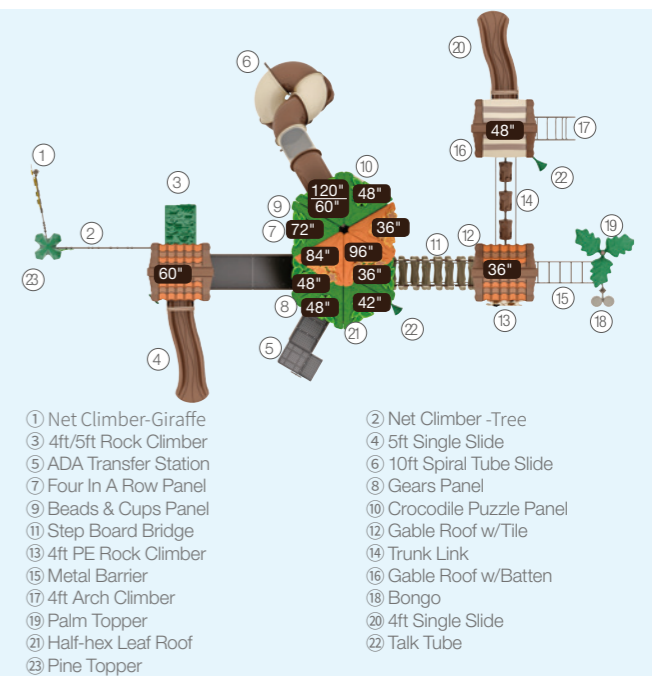



NEW



## ALOHA | AT50TH-0011

Ages: 2-12  
 Fall Height: 56"  
 Use Zone: 50'x36'  
 Equipment Size: 37'11"x23'5"x16'

### COLOR

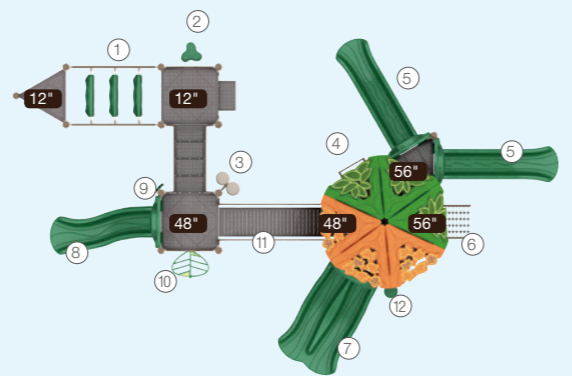

- ① Teater Tunnel
- ② Clover Step
- ③ Bongo
- ④ 4ft Straight Rung Climber
- ⑤ 5ft Sectional Slide
- ⑥ 5ft Net Climber
- ⑦ 4ft Double Slide
- ⑧ 4ft Single Slide
- ⑨ Rain Wheel
- ⑩ 4ft Leaf Climber
- ⑪ Arch Bridge w/Handrails



## ALL SEASON TREEHOUSE | AT50TH-0003

Ages: 5-12  
 Fall Height: 72"  
 Use Zone: 42'x42'  
 Equipment Size: 29'9"x29'4"x17'5"

### COLOR

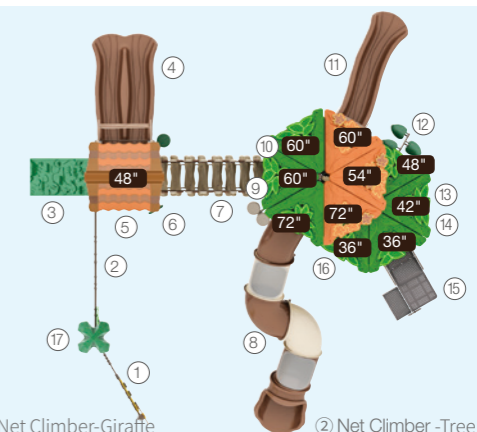

- ① Net Climber-Giraffe
- ② Net Climber-Tree
- ③ 4ft/5ft Rock Climber
- ④ 4ft Double Slide
- ⑤ Gable Roof w/Tile
- ⑥ Rain Wheel
- ⑦ Step Board Bridge
- ⑧ Bongo
- ⑨ 5ft Single Slide
- ⑩ Hex Leaf Roof
- ⑪ Half-hex Leaf Roof
- ⑫ 4ft Leaf Step Climber
- ⑬ Four In A Row Panel
- ⑭ ADA Transfer Station
- ⑮ Small Growth Ring & Clock Panel
- ⑯ Pine Topper







## WisEMAX Castle



### CASTLE PEAK | AT50CS-0001

Ages: 5-12  
 Fall Height: 120"  
 Use Zone: 52'x60"  
 Equipment Size: 48'10"x37'8"x23'8"

#### COLOR

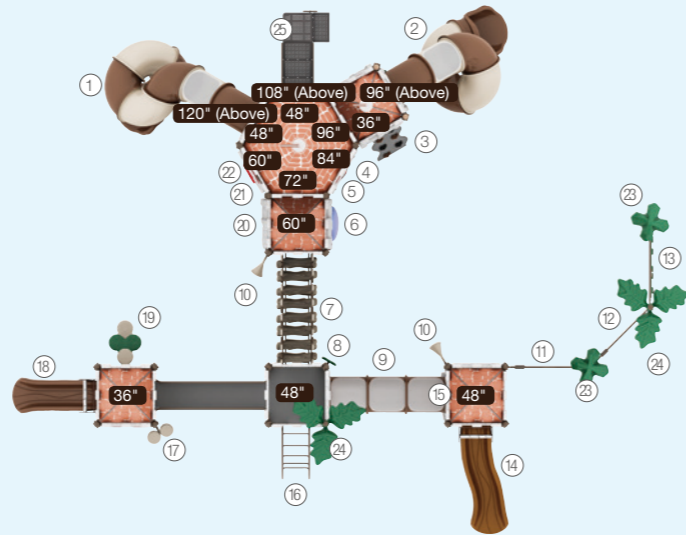

- ① 10ft Spiral Tube Slide (Gray)
- ② 8ft Spiral Tube Slide (Gray)
- ③ 3ft PE Wave Rock Climber
- ④ Clock Panel
- ⑤ Kitchen Panel (Below)
- ⑥ Bubble Window Panel
- ⑦ Step Board Bridge w/Handrail
- ⑧ Rain Wheel
- ⑨ Crawl Tunnel
- ⑩ Megaphone
- ⑪ Net Climber-Rock
- ⑫ Net Climber-Leaf
- ⑬ Net Climber-Ladybird
- ⑭ 4ft Single Slide
- ⑮ Flower Bed Panel
- ⑯ 4ft Arch Climber
- ⑰ Bongo
- ⑱ 3ft Trunk Climber
- ⑲ 3ft PE Wave Rock Climber
- ⑳ Crocodile Puzzle Panel
- ㉑ Counter Panel (Below)
- ㉒ World Map Panel
- ㉓ Pine Topper
- ㉔ Palm Topper
- ㉕ ADA Transfer Station



### WOODLANDS FORT | AT50CS-0003

Ages: 5-12  
 Fall Height: 60"  
 Use Zone: 39'x40"  
 Equipment Size: 26'6"x27'2"x19'1"

#### COLOR

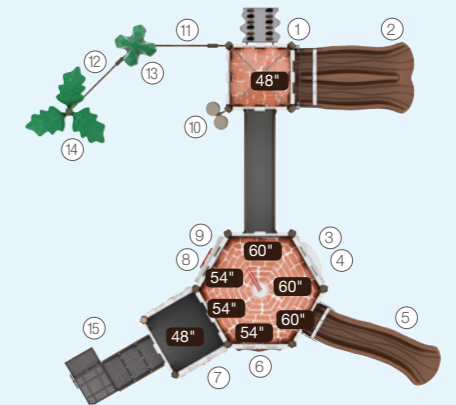

- ① 4ft PE Wave Rock Climber
- ② 4ft Double Slide
- ③ Crocodile Puzzle Panel (Below)
- ④ Bubble Window Panel (Above)
- ⑤ 5ft Single Slide
- ⑥ Kitchen Panel
- ⑦ Clock Panel
- ⑧ Counter Panel (Below)
- ⑨ World Map Panel (Above)
- ⑩ Bongo
- ⑪ Net Climber-Rock
- ⑫ Net Climber-Leaf
- ⑬ Pine Topper
- ⑭ Palm Topper
- ⑮ ADA Transfer Station







## BRIGHTWATER FORTRESS | AT50CS-0002

Ages: 2-5  
 Fall Height: 48"  
 Use Zone: 44'x40'  
 Equipment Size: 32'x26'7"x16'4"

### COLOR

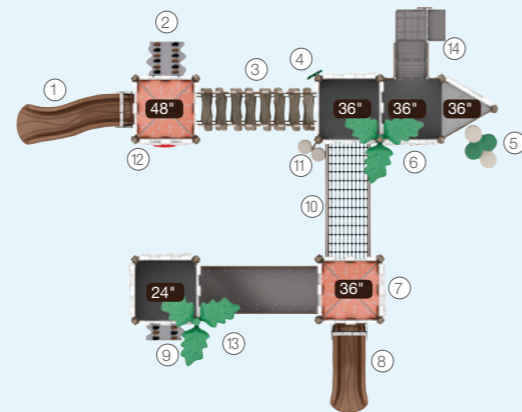

- ① 4ft Single Slide
- ② 4ft PE Wave Rock Climber
- ③ Step Board Bridge w/Handrail
- ④ Rain Wheel
- ⑤ 3ft Trunk Climber
- ⑥ Clock Panel
- ⑦ Crocodile Puzzle Panel
- ⑧ 3ft Single Slide
- ⑨ 2ft PE Wave Rock Climber
- ⑩ Arch Net Bridge w/Metal Barrier
- ⑪ Bongo
- ⑫ Counter Panel (Below)
- ⑬ Pine Topper
- ⑭ ADA Transfer Station



## MOUNTAIN PALACE | AT50CS-0004

Ages: 2-5  
 Fall Height: 48"  
 Use Zone: 48'x40'  
 Equipment Size: 35'1"x27'7"x17'10"

### COLOR

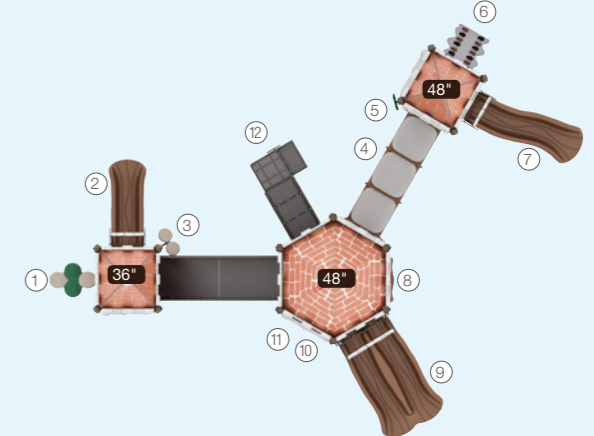

- ① 3ft Trunk Climber
- ② 3ft Single Slide
- ③ Bongo
- ④ Crawl Tunnel
- ⑤ Rain Wheel
- ⑥ 4ft PE Wave Rock Climber
- ⑦ 4ft Single Slide
- ⑧ Kitchen Panel
- ⑨ 4ft Double Slide
- ⑩ Clock Panel (Above)
- ⑪ Harp Panel (Below)
- ⑫ ADA Transfer Station





## WiseMAX Pirate Ship



### SCALAWAGS | AT50PS-0001

Ages: 2-12  
 Fall Height: 120"  
 Use Zone: 70'x55'  
 Equipment Size: 57'9"x30'9"x24'11"

#### COLOR

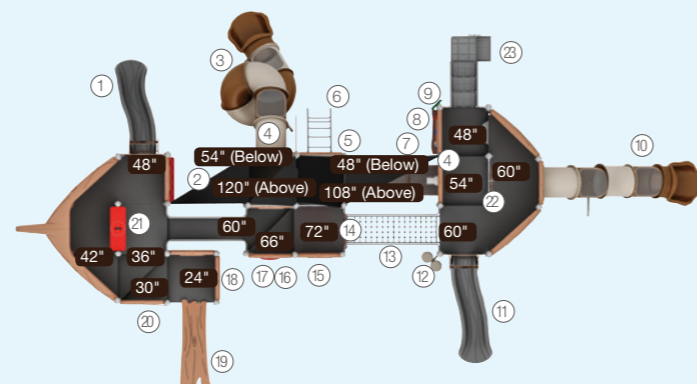

- |                                   |                            |
|-----------------------------------|----------------------------|
| ① 4ft Single Slide                | ② Bubble Window Panel      |
| ③ 10ft Spiral Tube Slide          | ④ Cannon Panel             |
| ⑤ Clock Panel (Above)             | ⑥ 4ft Arch Climber (Brown) |
| ⑦ Crawl Tunnel                    | ⑧ Drums Panel              |
| ⑨ Rain Wheel                      | ⑩ 5ft Tube Slide           |
| ⑪ 5ft Single Slide                | ⑫ Bongo                    |
| ⑬ Arch Net Bridge w/Metal Barrier | ⑬ Kitchen Panel            |
| ⑮ Crocodile Puzzle Panel          | ⑮ ABC Panel (Above)        |
| ⑰ Counter Panel (Below)           | ⑰ Maze Panel               |
| ⑲ PE Diving Board                 | ⑲ World Map Panel          |
| ⑳ Compass Worktop                 | ㉑ Helm                     |
| ㉒ ADA Transfer Station            |                            |



### ATLANTIS SEAS | AT50PS-0002

Ages: 2-12  
 Fall Height: 60"  
 Use Zone: 54'x41'  
 Equipment Size: 41'11"x28'8"x17'1"

#### COLOR

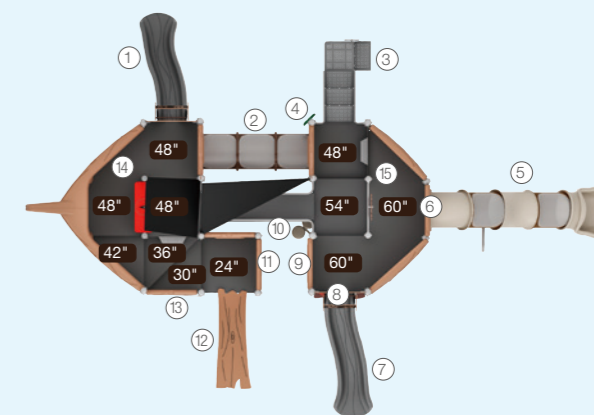

- |                        |                               |
|------------------------|-------------------------------|
| ① 4ft Single Slide     | ② Crawl Tunnel                |
| ③ ADA Transfer Station | ④ Rain Wheel                  |
| ⑤ 5ft Tube Slide       | ⑥ Bubble Window Panel (Below) |
| ⑦ 5ft Single Slide     | ⑧ Drums Panel (Below)         |
| ⑨ ABC Panel            | ⑩ Bongo                       |
| ⑪ Maze Panel           | ⑪ PE Diving Board             |
| ⑬ World Map Panel      | ⑬ Compass Worktop             |
| ⑮ Helm                 |                               |







www.wisdomplaygrounds.com

# WiseFIT

WiseFIT series is the perfect solution for any community that is in need of a more physically challenging play structure. This series involves a large variety of climbing, hanging, balances, and slides that can be individually placed or combined to create imaginative play spaces. These structures provide numerous building blocks for overall coordination, which include attention and concentration, body awareness, muscular endurance, sensory processing, and isolated movement. These are some of the many building blocks this series provides.

- 181 WiseCIRCUIT
- 182 WiseXR



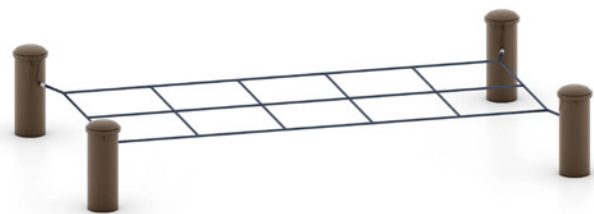

**NEW**

**HORIZONTAL PLAYGROUND NET**  
**LS-JSQC004**

Age: 5-12  
Use Zone: 19'x16'  
Equipment Size: 6'6"x4'x1'2"



**NEW**

**LEAP PADS**  
**LS-JSQC005-112123**

Age: 5-12  
Use Zone: 27'x16'  
Equipment Size: 14'10"x3'7"x1'



**NEW**

**WAVY PARALLEL BARS**  
**LS-JSQC003**

Age: 5-12  
Use Zone: 19'x15'  
Equipment Size: 6'8"x2'9"x3'11"

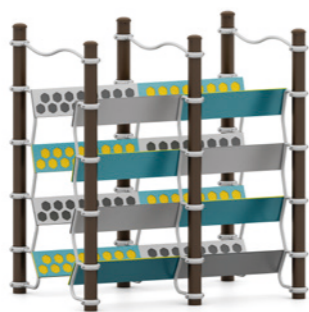

**NEW**

**LEAP CLIMBER**  
**LS-JSQC001**

Age: 5-12  
Fall Height: 72"  
Use Zone: 20'x18'  
Equipment Size: 7'6"x5'4"x8'1"

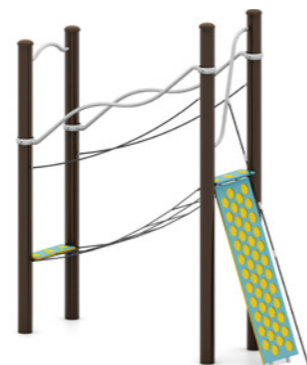

**NEW**

**NET & ROCK CLIMBER**  
**LS-JSQC002**

Age: 5-12  
Fall Height: 60"  
Use Zone: 21'x15'  
Equipment Size: 9'x2'9"x9'8"

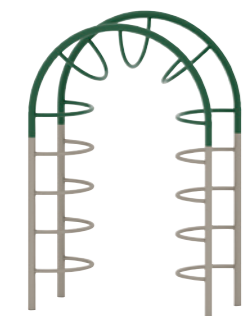

**UP & OVER CLIMBER**  
**63-21029-110113**

Age: 5-12  
Fall Height: 89"  
Use Zone: 17'x15'  
Equipment Size: 4'11"x2'6"x7'5"



**DOUBLE UP & OVER CLIMBER**  
**63-21031-111**

Age: 5-12  
Fall Height: 89"  
Use Zone: 27'x15'  
Equipment Size: 14'2"x2'6"x7'5"

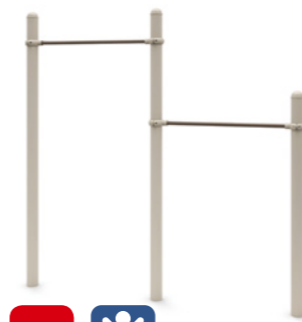

**NEW**

**WISE DUAL LEVEL**  
**QSFS-CL0020N**

Age: 5-12  
Fall Height: 75"  
Use Zone: 20'x13'  
Equipment Size: 7'2"x6"x7'1"



**NEW**

**WISE BENCH**  
**79-23001**

Age: 5-12



**NEW**

**WISE TRI - LEVEL BARS**  
**QSFS-CL0021N**

Age: 5-12  
Fall Height: 75"  
Use Zone: 23'x13'  
Equipment Size: 10'6"x6"x7'1"



**NEW**

**WISE BACK STRETCH**  
**79-23002**

Age: 5-12

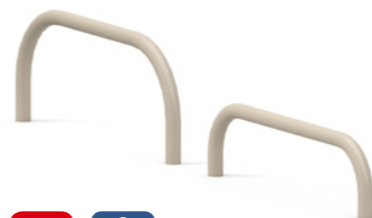

**NEW**

**WISE PUSH UP BARS**  
**79-23003**

Age: 5-12



**NEW**

**WISE LIFT**  
**79-23004**

Age: 5-12



**NEW**

**WISE STEP UP**  
**79-23005**

Age: 5-12



# WiseWORX

WiseWORX series is the perfect solution for any community that is in need of a more physically challenging play structure. This series includes our new WiseNEX system which incorporates a variety of nets and ropes. You will also find our New WiseSPHERE equipment within this section. These are dome shaped spheres that can be used individually to enhance the versatility and look of any play area. Our hexagon shaped WiseQUBES have gone through an upgrade, to have more variety in the size and way they are used with other components. These structures provide numerous building blocks for overall coordination, which include attention and concentration, body awareness, muscular endurance, sensory processing, and isolated movement. These are some of the many building blocks this series provides.

- 183 WiseNEX
- 188 WiseQUBES
- 191 WiseROCK
- 193 WiseSPHERE
- 195 MOTOR SKILLS TRAIN
- 197 WiseFREE



**NEW**

## TRIFECTA CHALLENGE PDFS-CL0024C

Ages: 2-12  
 Fall Height: 84"  
 Use Zone: 52'x38'  
 Equipment Size: 39'5" x 25'3" x 10'

### COLOR

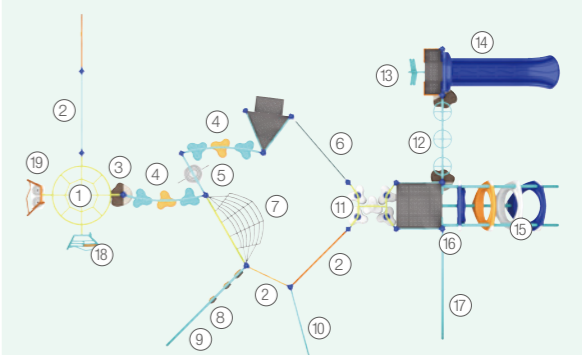

- |                          |                                       |
|--------------------------|---------------------------------------|
| ① Overhead Challenger    | ⑫ Single Post Overhead Rotating Rings |
| ③ Bear Step              | ⑬ 5ft Sectional Slide                 |
| ④ 3 Clover Steps Bridge  | ⑭ 5ft Arch O-zone Climber             |
| ⑤ Jumbo Round Stepper    | ⑮ Crescent PE Climber                 |
| ⑦ Inclined Net Climber   | ⑯ 6ft PE Climber w/Deck               |
| ⑧ Arch PE Crawl Panel    |                                       |
| ⑨ Climbing Arc           |                                       |
| ⑪ Round Climbing Stepper |                                       |



**FUN WAYS**  
**PDFS-CL0011C**

Ages: 5-12  
Fall Height: 84"  
Use Zone: 41'x32'  
Equipment Size: 28'11"x19'2"x8'1"

**COLOR**

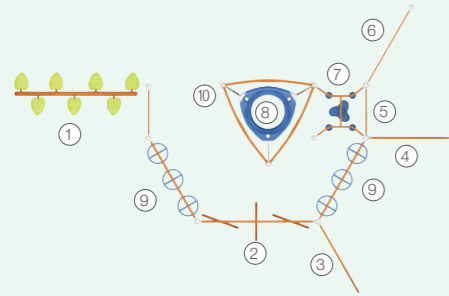

- ① Leaf Balance Beam
- ② Lilly Pad Walk
- ③ PE Honeycomb Climbing Arc
- ④ Sail PE Climbing Panel
- ⑤ Power Rungs
- ⑥ Vertical Net Link
- ⑦ Round Climbing Stepper
- ⑧ O-zone Climber
- ⑨ Single Post Overhead Rotating Rings
- ⑩ Triangle Overhead Challenger

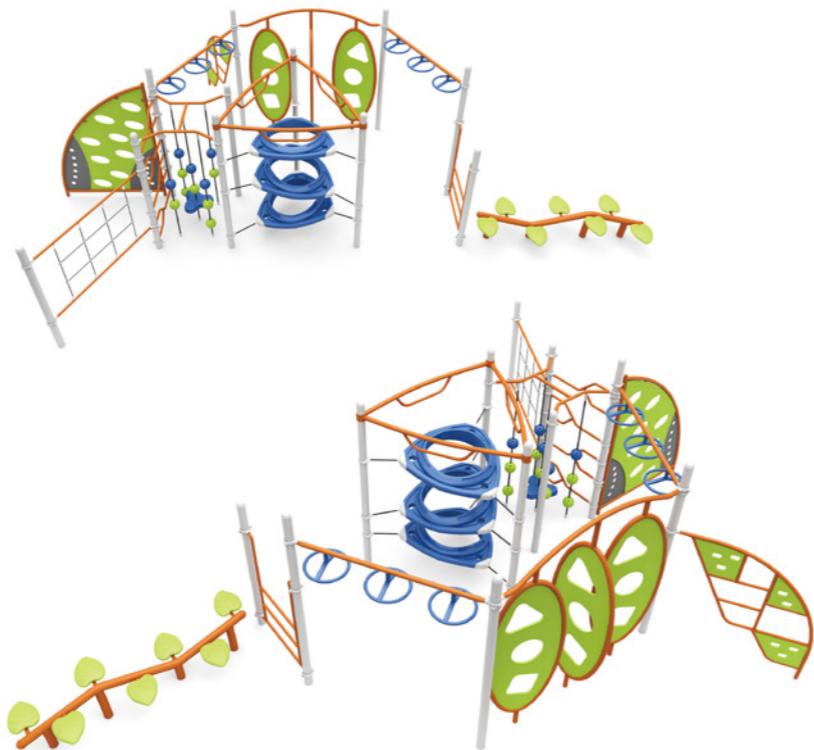

**WOBBLEY WAY**  
**PDFS-CL0012C**

Ages: 5-12  
Fall Height: 84"  
Use Zone: 42'x39'  
Equipment Size: 29'2"x26'1"x8'2"

**COLOR**

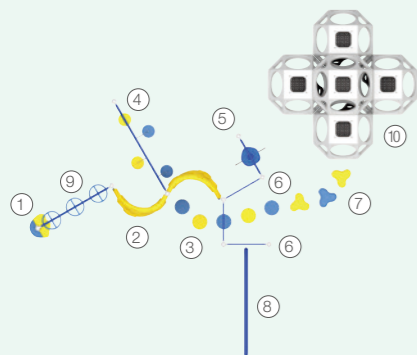

- ① Bear Step
- ② Vertical Rock Climber
- ③ 12" Single Trunk Climber
- ④ Swing Discs
- ⑤ Jumbo Round Stepper
- ⑥ Single Bar
- ⑦ 18" Clover Step
- ⑧ Balance Beam 8ft
- ⑨ Single Post Overhead Rotating Rings
- ⑩ Ruby Qube

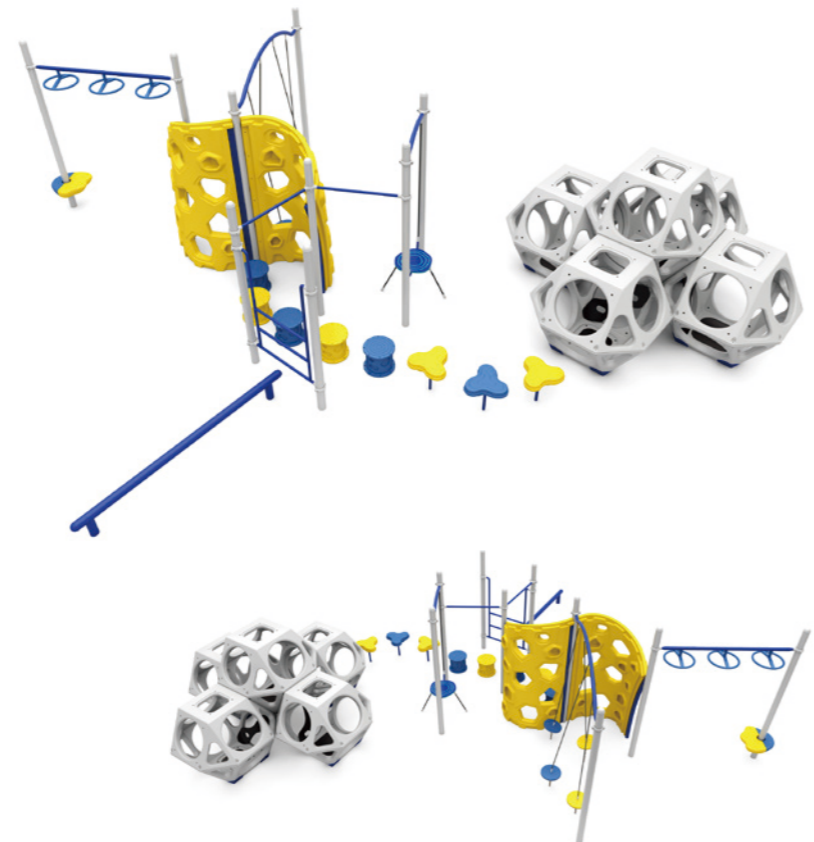

**DOJO I PDFS-CL0031C**

Ages: 5-12  
Fall Height: 96"  
Use Zone: 51'x43'  
Equipment Size: 38'10"x30'11"x8'10"

**COLOR**

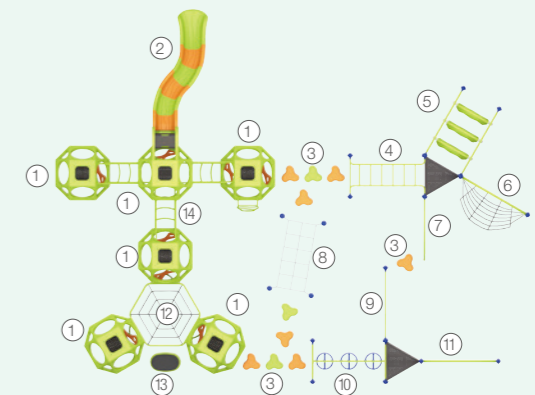

- ① Qubest
- ② 6ft S-shape Sectional Slide
- ③ 6" Clover Step
- ④ Challenge Ladder
- ⑤ Horizontal O-zone Climber
- ⑥ Inclined Net Climber
- ⑦ PE Honeycomb Climbing Arc
- ⑧ Horizontal Playground Net
- ⑨ Power Rungs
- ⑩ Overhead Rotating Rings
- ⑪ Honeycomb Net Climber
- ⑫ G
- ⑬ S
- ⑭ C



## WILDER PDFS-CL0030C

Ages: 5-12  
Fall Height: 96"  
Use Zone: 51'x32'  
Equipment Size: 38'8"x19'1"x8'10"

### COLOR

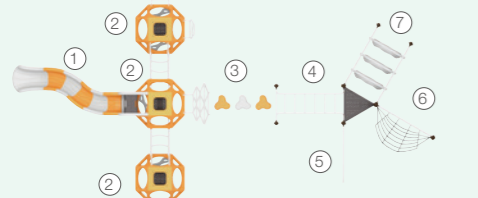

- ① 6ft S-shape Sectional Slide
- ② Qubest
- ③ 6" Clover Step
- ④ Challenge Ladder
- ⑤ PE Honeycomb Climbing Arc
- ⑥ Inclined Net Climber
- ⑦ Horizontal O-zone Climber

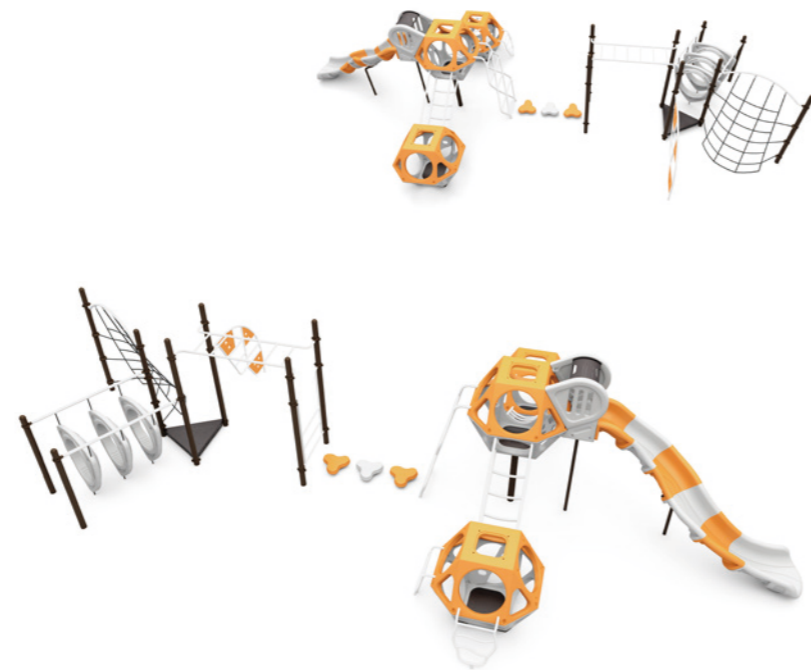

## SPIDER CLIMBER PDFS-CL0028C

Age: 5-12  
Fall Height: 84"  
Use Zone: 29'x32'  
Equipment Size: 17'x15'10"x7'10"

### COLOR

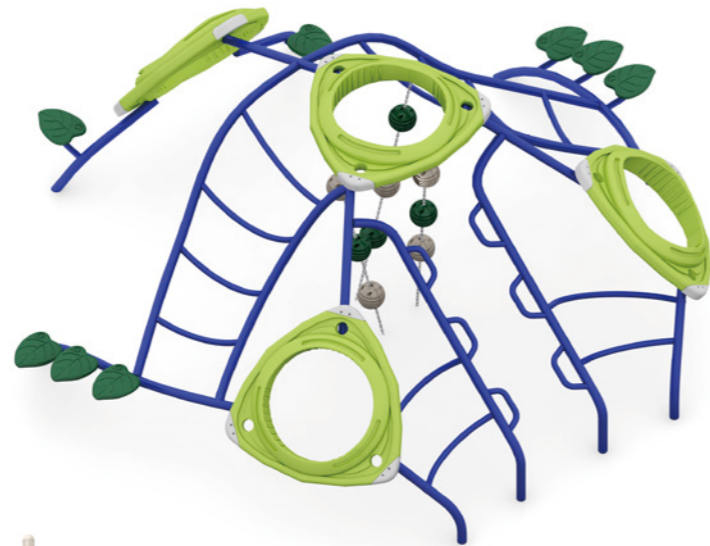

## SHIMMY FS-CL0022N

Age: 5-12  
Fall Height: 96"  
Use Zone: 19'x18'  
Equipment Size: 6'5"x5'10"x9'1"

### COLOR



## TEATER TUNNEL FS-CL0023N

Age: 5-12  
Fall Height: 48"  
Use Zone: 13'x15'  
Equipment Size: 6'x4'9"x4'6"

### COLOR



## DRAGONFLY | PDQB-210013C

Ages: 5-12  
Fall Height: 123"  
Use Zone: 37'x38'  
Equipment Size: 24'9"x25'11"x10'3"

### COLOR

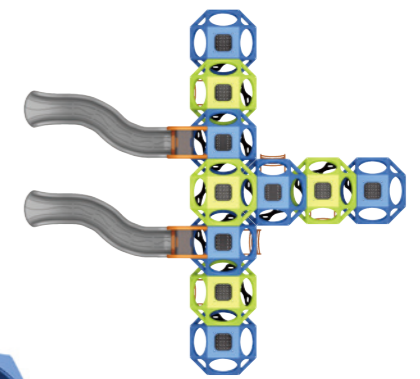





## VISIONARY I PDQB-210010C

Ages: 5-12  
 Fall Height: 96"  
 Use Zone: 31'x43'  
 Equipment Size: 18'2"x30'1"x8'10"

### COLOR

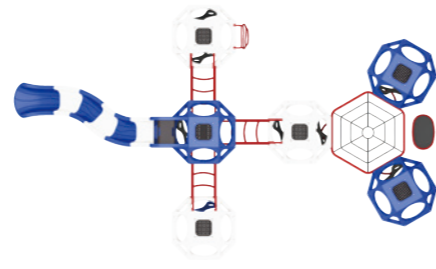

## DOUBLE TROUBLE QUBE I QB-210003

Age: 5-12  
 Fall Height: 72"  
 Use Zone: 30'x29'  
 Equipment Size: 17'11"x16'5"x6'11"

### COLOR



## QUBE CLIMB AND SLIDE I QB-210012P

Ages: 5-12  
 Fall Height: 108"  
 Use Zone: 31'x29'  
 Equipment Size: 18'3"x16'2"x8'10"

### COLOR



## GRAVITRON I QB-210009N

Age: 5-12  
 Fall Height: 48"  
 Use Zone: 26'x25'  
 Equipment Size: 13'6"x12'2"x4'1"

### COLOR



## PROFESSORS QUBE I QB-210005

Age: 5-12  
 Fall Height: 72"  
 Use Zone: 30'x29'  
 Equipment Size: 17'11"x14'8"x6'

### COLOR







**PARK AVENUE | MR-210006N**

Age: 5-12  
 Fall Height: 82"  
 Use Zone: 43'x21'

**COLOR**



**DOUBLE ARCH | MR-210005P**

Age: 5-12  
 Fall Height: 82"  
 Use Zone: 28'x20'

**COLOR**

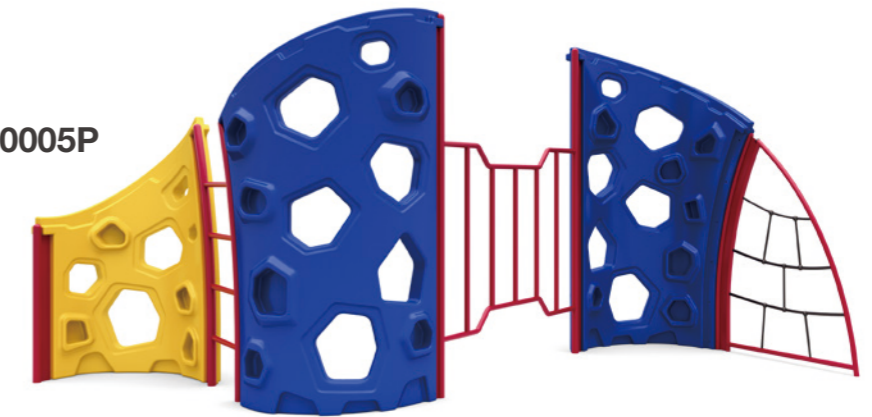

**BALANCED ROCK | MR-210001C113122**

Age: 5-12  
 Fall Height: 82"  
 Use Zone: 20'x16'

**COLOR**

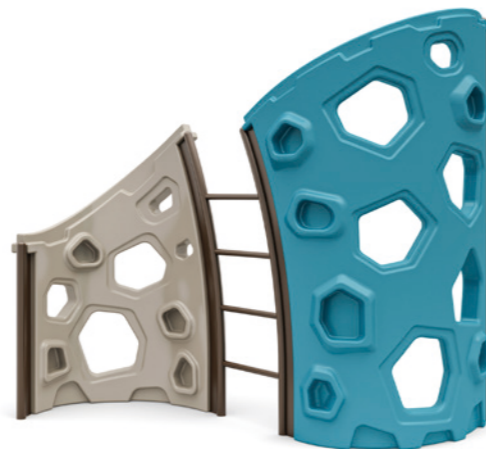

**DELICATE ARCH | MR-210002C113123**

Age: 5-12  
 Fall Height: 82"  
 Use Zone: 20'x17'

**COLOR**



**THE WINDOWS | MR-210003C113130**

Age: 5-12  
 Fall Height: 82"  
 Use Zone: 23'x23'

**COLOR**



**LA SAL | MR-210004C114122**

Age: 5-12  
 Fall Height: 82"  
 Use Zone: 27'x18'

**COLOR**







**NEW**

**HURRAH I WS-210001C116**

Age: 5-12  
Fall Height: 54"  
Use Zone: 37'x22'

**COLOR**

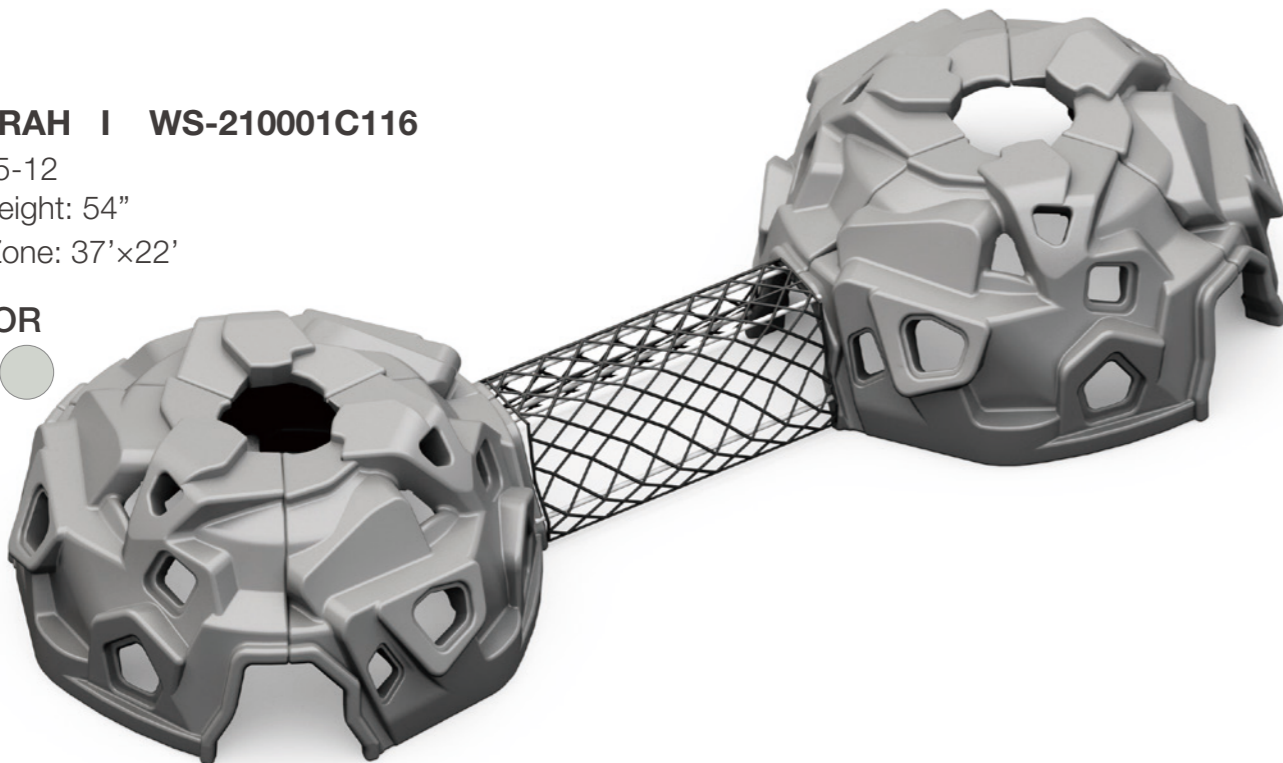

**NEW**

**ARCHES WS-210002C114121**

Age: 5-12  
Fall Height: 56"  
Use Zone: 27'x18'

**COLOR**



DiscoverSPHERE ▶



**NEW**

**CANYON LANDS WS-210003C77121122**

Age: 5-12  
Fall Height: 55"  
Use Zone: 26'x25'

**COLOR**



**NEW**

**BUGGY WS-210004C114120123**

Age: 5-12  
Fall Height: 56"  
Use Zone: 26'x25'

**COLOR**

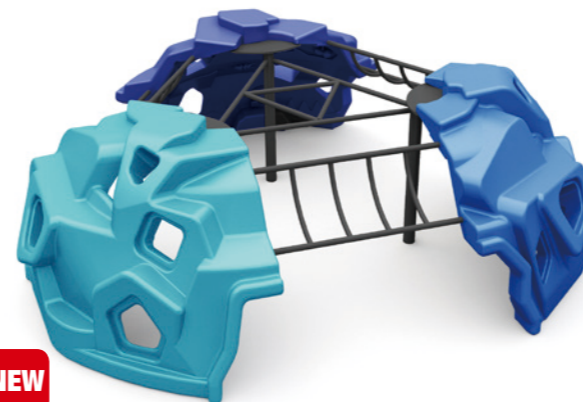

**NEW**

**SLICKROCK WS-210005C113114118**

Age: 5-12  
Fall Height: 54"  
Use Zone: 22'x22'

**COLOR**

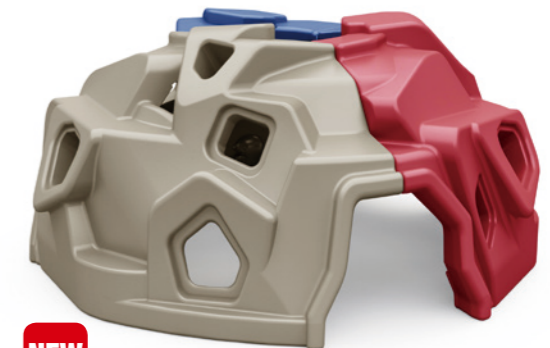



## OUTDOOR MOTOR SKILLS-TRAIN

### MECHANICAL TRAIN + WAVED RAIL DESIGN

Release children's vitality with lifelike appearance, exercise children's balance and control.

### VARIOUS MODULES FOR EXTENDABLE CONNECTION

A variety of functions, including bridging/climbing/balancing/rope maze/crawling and other activity design, training children's balance, coordination, sensitivity and muscle strength.



Outdoor Motor Skills-Train-Engine  
**HW1-S1A359**



Outdoor Motor Skills-Train-Bridging Carriage  
**HW1-S1A354**



Outdoor Motor Skills-Train-Climbing Carriage  
**HW1-S1A355**



Outdoor Motor Skills-Train-Entrance Carriage  
**HW1-S1A356**



1 Gears Game Panel

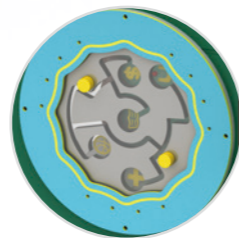

2 Beads & Cups Panel

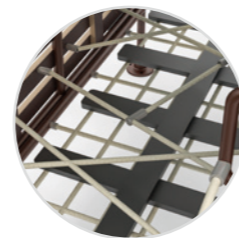

3 Rope Maze



### OUTDOOR MOTOR SKILLSTRAIN-REGULAR SET **HW1-S1A352**

Ages: 2-5  
Use Zone: 64' x 19'



### OUTDOOR MOTOR SKILLSTRAIN-CORNER SET **HW1-S1A353**

Ages: 2-5  
Use Zone: 39' x 42'

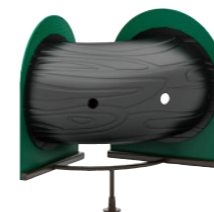

Outdoor Motor Skills-Train-Crawl Tunnel  
**HW1-S1A365**



Outdoor Motor Skills-Train-Climbing Bridge  
**HW1-S1A358**

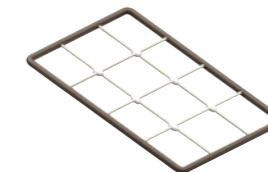

Outdoor Motor Skills-Train-Net Bridge  
**HW1-S1A596**

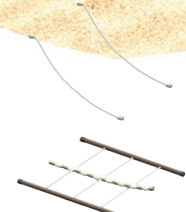

Outdoor Motor Skills-Train-Ropes Balance  
**HW1-S1A360**



Outdoor Motor Skills-Train-Logs Balance  
**HW1-S1A362**



Outdoor Motor Skills-Train-Stumps Balance  
**HW1-S1A361**

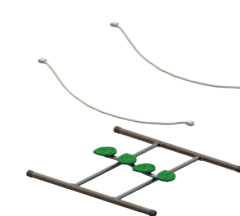

Outdoor Motor Skills-Train-Stepping Leaves Balance Bar  
**HW1-S1A363**



Outdoor Motor Skills-Train-Mushroom Stones Balance Bar  
**HW1-S1A364**





**NEW** 3.5 360°

**360 FREESTANDING SPIRAL SLIDE  
FS-SL7200N**

Ages: 5-12  
Fall Height: 72"  
Use Zone: 26'x18'  
Equipment Size: 13'2"x5'7"x10'



**NEW** 3.5 270°

**270 FREESTANDING SPIRAL SLIDE  
FS-SL6000P**

Ages: 5-12  
Fall Height: 60"  
Use Zone: 23'x18'  
Equipment Size: 10'9"x5'10"x9'1"



**NEW** 3.5

**WIGGLY RACE  
FS-SL72033N**

Ages: 2-12  
Fall Height: 72"  
Use Zone: 31'x27'  
Equipment Size: 19'x14'1"x10'1"



**NEW** 3.5

**4' FREESTANDING SINGLE SLIDE  
FS-SL4801N**

Ages: 2-12  
Fall Height: 48"  
Use Zone: 25'x17'  
Equipment Size: 12'7"x4'3"x8'1"



**NEW** 3.5

**4' FREESTANDING DOUBLE SLIDE  
FS-SL4802P**

Ages: 2-12  
Fall Height: 48"  
Use Zone: 27'x17'  
Equipment Size: 14'6"x4'8"x8'1"

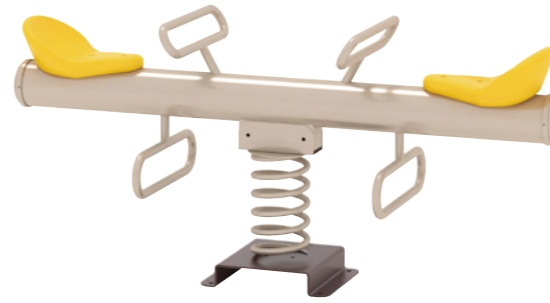

**DUO-SEESAW  
SR-21005**

Ages: 2-12  
Use Zone: 12'x8'  
Equipment Size: 5'2"x1'2"x2'4"

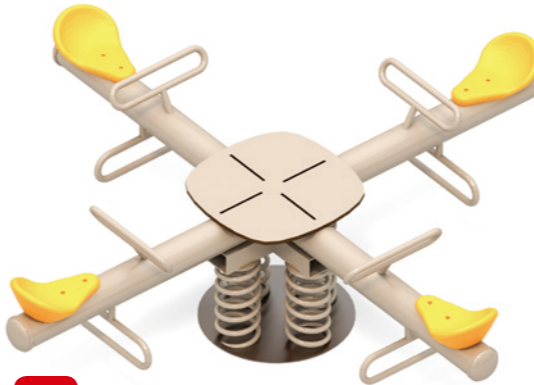
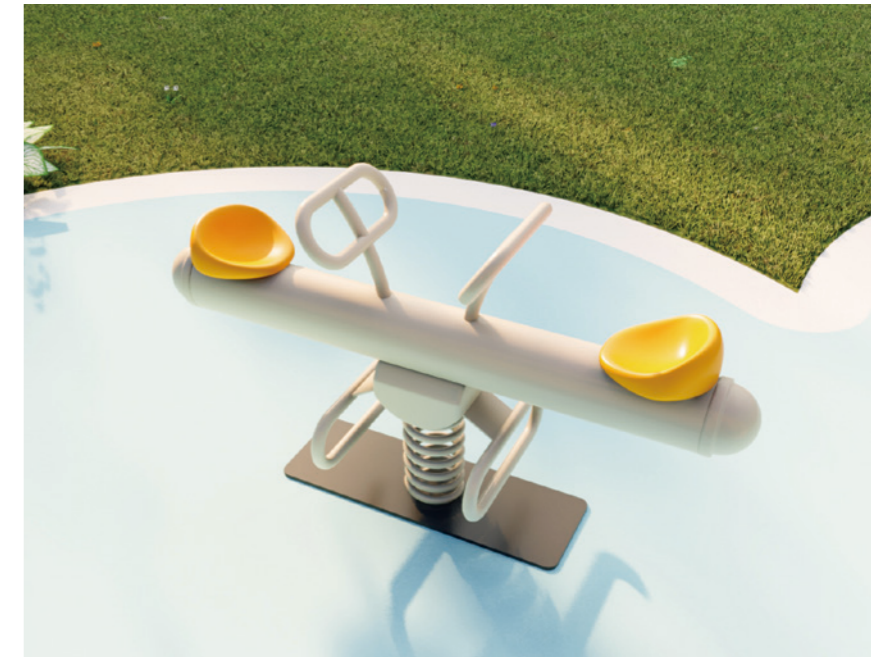

**NEW**  
**QUAD-SEESAW  
SR-21012-113**

Ages: 2-12  
Use Zone: 20'x20'  
Equipment Size: 7'10"x7'10"x2'4"



**NEW**  
**TRI-SEESAW  
SR-21009**

Ages: 2-12  
Use Zone: 19'x19'  
Equipment Size: 6'1"x6'11"x2'4"



**NEW**  
**BOUNCE AND BALANCE  
SR-21010**

Ages: 2-12  
Use Zone: 23'x16'  
Equipment Size: 10'8"x3'2"x3'10"







**NEW**

**WEE TREE SWING**  
75-21020-110113

Ages: 2-12  
Use Zone: 16'x14'  
Equipment Size: 3'10"x1'8"x4'4"



**NEW**

**ROCK AND ROLL ON**  
76AM-002

Ages: 2-12  
Equipment Size: 9'2"x6'6"x5'2"



**NEW**

**SENSORY STATION QUAD SET**  
FS-WP0002C

Equipment Size: 7'8"x7'9"x4'2"

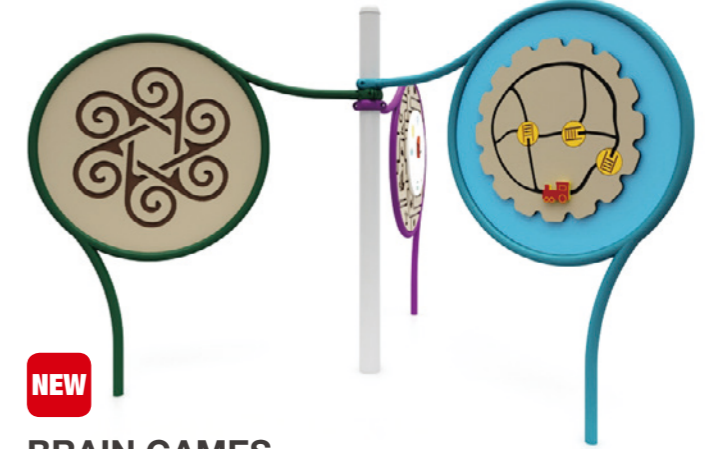

**NEW**

**BRAIN GAMES**  
PDFS-CL0010C

Equipment Size: 6'5"x7'5"x5'1"

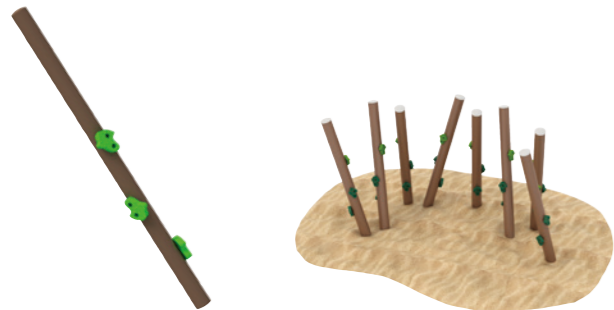

**THROUGH THE JUNGLE-SINGLE**  
HW1-S101

Ages: 2-12  
Equipment Size: 1'0"x1'10"x5'3"



**GFRC STUMP JUMP**  
63-21078

Ages: 2-12  
Equipment Size: 4'8"x1'x2'1"



**NEW**

**SENSORY STATION PAIR**  
FS-WP0005C

Equipment Size: 3'11"x3'11"x4'2"



**NEW**

**TRIPLE BIKE RACK**  
72-21017-111

Equipment Size: 1'1"x2'



**NEW**

**WISE CUSTOMIZABLE BENCH**  
SA-21007-110

Equipment Size: 8'1"x2'10"x2'10"



**NEW**

**HANG AND SPIN**  
75-21032-110113

Ages: 2-12  
Use Zone: 19'x19'  
Equipment Size: 6'6"x6'8"x7'9"



**NEW**

**TWIRL A WHIRL**  
75-21014-114

Ages: 2-12  
Use Zone: 18'x18'  
Equipment Size: 5'10"x5'10"x3'3"



**SPIN BOARD**  
75-21005

Ages: 2-12  
Use Zone: 14'x14'  
Equipment Size: 1'8"x1'8"x3"



**NEW**

**46" ROUND TABLE 4 SEATS DIAMOND PATTERN**  
KB4-7204-110

Equipment Size: 6'8"x6'8"x2'7"



**NEW**

**ADA 46" ROUND TABLE 3 SEATS DIAMOND PATTERN**  
KB4-7205-110

Equipment Size: 6'8"x6'x2'7"



**NEW**

**8FT RECTANGLE TABLE DIAMOND PATTERN**  
SA-21003-110

Equipment Size: 8'x5'3"x2'7"



# NatureWISE

Wisdom's NatureWISE series was inspired by the many wonders of nature. Combining the adventure and excitement of nature with the durability, safety and low maintenance of high-quality play equipment, equals the perfect combination for endless amounts of imagination play.

- 203 NatureCHALLENGE
- 209 NaturePLAY Theme
- 215 NatureMAX Theme



[www.wisdomplaygrounds.com](http://www.wisdomplaygrounds.com)



# NatureCHALLENGE

Wisdom's NatureCHALLENGE series is the perfect solution for any community that is in need of a more physically challenging play structure, with a variety of nature-themed elements, that can also be customized.

The NatureCHALLENGE series integrates large-scale comprehensive equipment and a elements of sensory play that help children to develop their physical abilities. This supports children to explore their surroundings more autonomously while using a wide range of activities. It also promotes the development of children's gross motor abilities and sensory processing.

All NatureWISE structures use high-end wood, which has its own anti-corrosion properties making it a strong and solid option with quality guaranteed. Wisdom's NatureWISE Series promotes the development of multiple skills in children through physical exercise.



## HANGING+BALANCING+CLIMBING

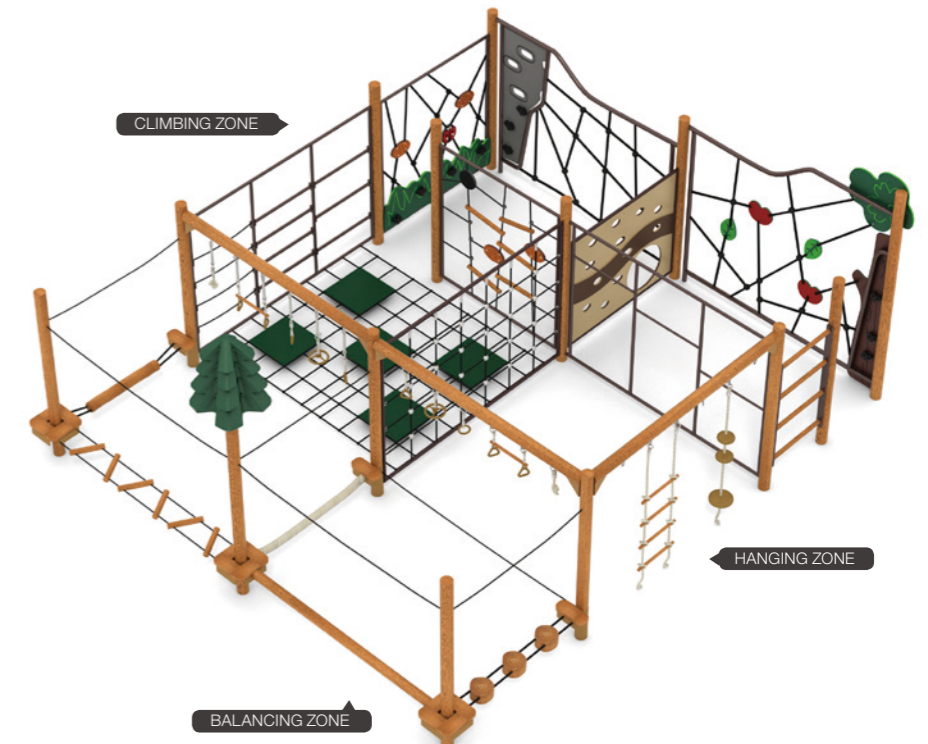
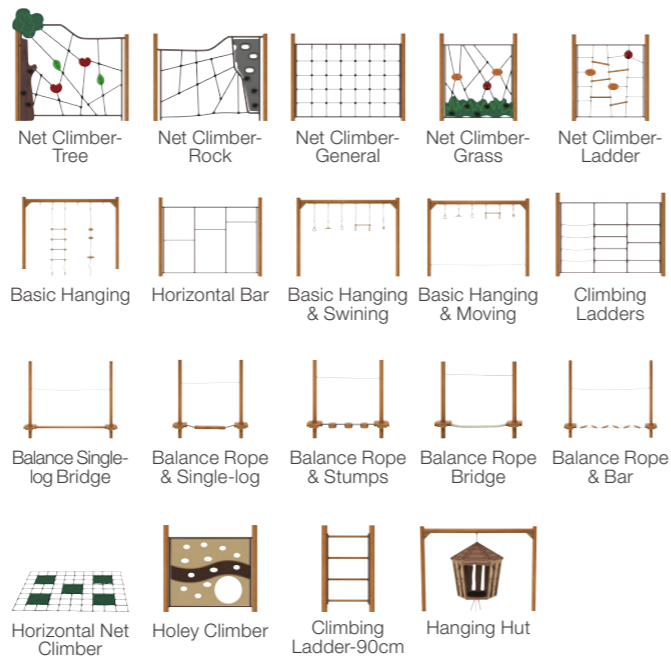

### HIKER'S HIDEOUT HW1-S291

Ages: 5-12

Fall Height: 82"

Use Zone: 34' x 31'



TreeHouse



Pirate Ship





## RUSTIC RIDGE HW1-S292

Ages: 5-12  
Fall Height: 82"  
Use Zone: 31' x 26'

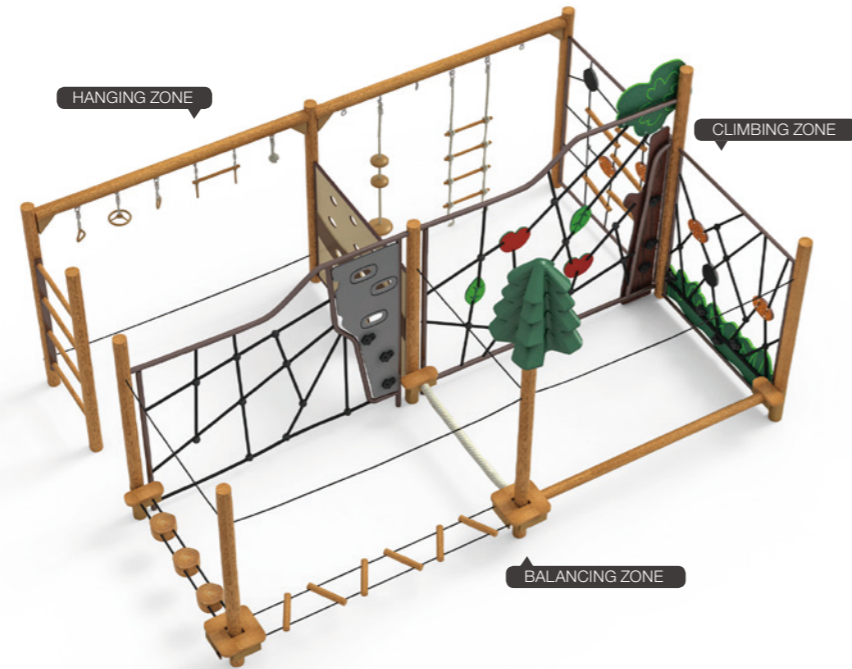

## WILDWOOD RETREAT HW1-S296

Ages: 5-12  
Fall Height: 82"  
Use Zone: 26' x 24'



## CAMPFIRE COVE HW1-S297

Ages: 5-12  
Fall Height: 82"  
Use Zone: 24' x 24'



## ADVENTURE CAMP HW1-S293

Ages: 5-12  
Fall Height: 82"  
Use Zone: 34' x 31'



## RIVERSIDE HW1-S298

Ages: 5-12  
Fall Height: 82"  
Use Zone: 39' x 18'



## PEACEFUL PINES HW1-S294

Ages: 5-12  
Fall Height: 82"  
Use Zone: 40' x 31'



## STARRY SKIES HW1-S299

Ages: 5-12  
Fall Height: 82"  
Use Zone: 39' x 18'







## HAWAIIAN HUT HW1-S289

Ages: 5-12  
Fall Height: 48"  
Use Zone: 31'x47'  
Equipment Size: 11'4"x26'1"x14'6"

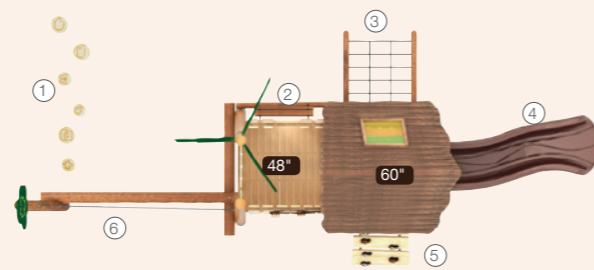

- ① Balance Stumps
- ② Rung Climber
- ③ Net Climber
- ④ 5ft Single Slide
- ⑤ Rock Climber
- ⑥ Single-log Bridge



**CHUCK**  
**HW1-S286**  
Ages: 5-12  
Fall Height: 24"  
Use Zone: 23'x23'



**ELLA**  
**HW1-S287**  
Ages: 5-12  
Fall Height: 24"  
Use Zone: 15'x24'

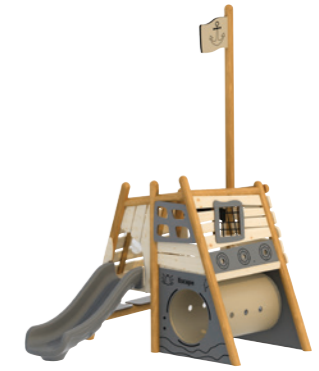

**HAL**  
**HW1-S288**  
Ages: 5-12  
Fall Height: 24"  
Use Zone: 23'x27'



THREE SECTION DESIGN-PROW & HULL & STERN



# NaturePLAY Theme

NaturePLAY features storybook like woodland elements, that encourage children to use their imaginations for outdoor play. This offers children the ability to transport to their own magical forests full of adventures. NaturePLAY structures are built with 4" square posts, which allows the structure to be lighter, and more versatile.

The NaturePLAY series is the perfect solution for any community that is in need of a more physically challenging play structure, with a variety of nature-themed elements, that can also be customized.

All NatureWISE structures use high-end solid quality wood, which has its own anti-corrosion properties making it a strong and solid option, with quality guaranteed.



**NEW**

## GROW AND GO | BE35TH-0001

Ages: 2-12

Fall Height: 84"

Use Zone: 58'x51'

Equipment Size: 45'2"x38'6"x18'7"

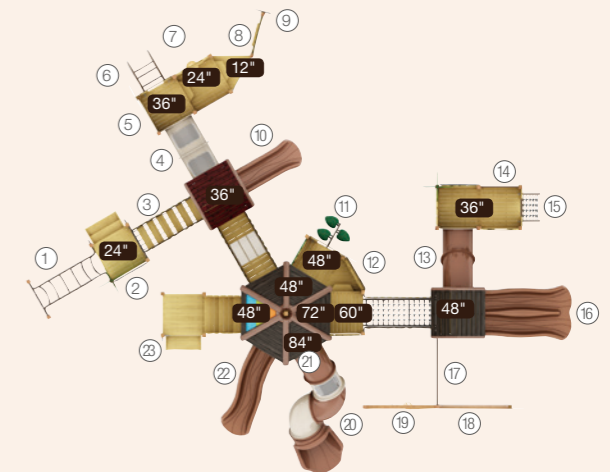

- ① Berlin - Invert Arch Ladder
- ② Balls & Flowers
- ③ Inclined Straight Bridge
- ④ Double Crawl Tunnel
- ⑤ Numbers & Letters Panel
- ⑥ 3ft Arch Climber
- ⑦ Cymbals Panel
- ⑧ Marimba Panel
- ⑨ Height Measure
- ⑩ 3ft Single Slide
- ⑪ 4ft Leaf Step Climber
- ⑫ Insect Panel
- ⑬ Inclined Crawl Tunnel
- ⑭ Food Match Panel
- ⑮ 3ft Net Climber
- ⑯ 4ft Double Slide
- ⑰ Net & Ladder Climbing
- ⑱ Single-log Bridge
- ⑲ Basic Hanging & Swinging
- ⑳ 7ft S-shape Tube Slide Right Turn
- ㉑ Plant Panel
- ㉒ 4ft Single Slide
- ㉓ ADA Transfer Station



NaturePLAY ADA



Castle TreeHouse Pirate Ship





## MIRKWOOD | BE35TH-0003

Ages: 5-12  
 Fall Height: 84"  
 Use Zone: 40'x17'  
 Equipment Size: 27'2"x3'11"x17'9"

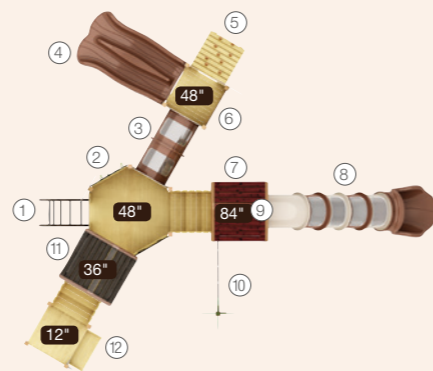

- ① 4ft Arch Climber
- ② Plant Panel
- ③ Double Crawl Tunnel
- ④ 4ft Double Slide
- ⑤ 4ft Wooden Panel Climber
- ⑥ Food Match Panel
- ⑦ Marimba Panel
- ⑧ 7ft Straight Tube Slide
- ⑨ Colorful Window Panel
- ⑩ Net Climbing
- ⑪ Numbers & Letters Panel
- ⑫ ADA Transfer Station



## BERNWOOD BE35TH-0006

Ages: 5-12  
 Fall Height: 84"  
 Use Zone: 40'x33'  
 Equipment Size: 27'1"x20'8"x16'9"

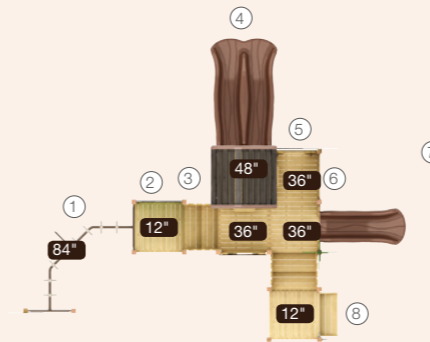

- ① 90° Overhead Swinging Rings
- ② Balls & Flowers
- ③ Counter Panel
- ④ 4ft Double Slide
- ⑤ 3ft Vertical Climber
- ⑥ Numbers & Letters Panel
- ⑦ 3ft Single Slide
- ⑧ ADA Transfer Station



## BRISTLECONE BE35TH-0009

Ages: 5-12  
 Fall Height: 72"  
 Use Zone: 38'x31'  
 Equipment Size: 25'8"x19'x19'11"

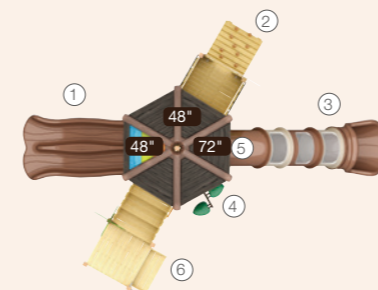

- ① 4ft Double Slide
- ② 4ft Wooden Panel Climber
- ③ 6ft Straight Tube Slide
- ④ 3ft Leaf Step Climber
- ⑤ Plant Panel
- ⑥ ADA Transfer Station





## KNIGHTS PLAY BE35CS-0008

Ages: 5-12  
Fall Height: 48"  
Use Zone: 36'x31'  
Equipment Size: 23'11" x 18'10" x 17'5"

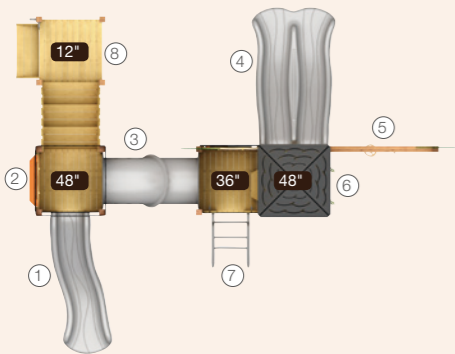

- ① 4ft Single Slide
- ② Counter Panel
- ③ Inclined Crawl Tunnel
- ④ 4ft Double Slide
- ⑤ Basic Hanging & Swinging
- ⑥ Plant Panel
- ⑦ 3ft Arch Climber
- ⑧ ADA Transfer Station



## DANCING MOLLY BE35PS-0004

Ages: 5-12  
Fall Height: 60"  
Use Zone: 45'x36'  
Equipment Size: 32'5" x 23'6" x 19'9"

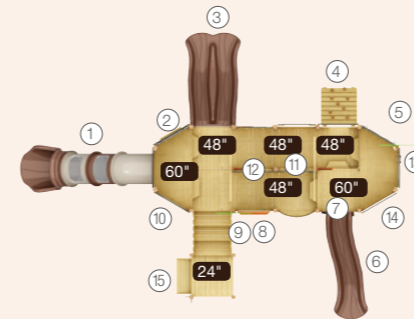

- ① 5ft Straight Tube Slide
- ② Kaleidoscope Panel
- ③ 4ft Double Slide
- ④ 4ft Wooden Panel Climber
- ⑤ Water Channel Panel
- ⑥ 5ft Single Slide
- ⑦ Sand Game Panel
- ⑧ Numbers & Letters Panel (Above)
- ⑨ Counter Panel (Below)
- ⑩ Colorful Window Panel
- ⑪ Bells Panel
- ⑫ Marimba Panel
- ⑬ Sand & Water Panel
- ⑭ Food Match Panel
- ⑮ ADA Transfer Station



## ELTZ BE35CS-0009

Ages: 5-12  
Fall Height: 48"  
Use Zone: 40'x30'  
Equipment Size: 27'2" x 17'11" x 18'7"

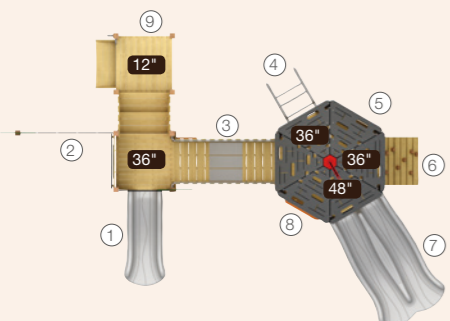

- ① 3ft Single Slide
- ② Net Climbing
- ③ Inclined Straight Bridge
- ④ 3ft Arch Climber
- ⑤ Numbers & Letters Panel
- ⑥ 3ft Wooden Panel Climber
- ⑦ 4ft Double Slide
- ⑧ Counter Panel
- ⑨ ADA Transfer Station



## SLOOP BE35PS-0006

Ages: 5-12  
Fall Height: 72"  
Use Zone: 41'x34'  
Equipment Size: 28'3" x 21'1" x 18'8"

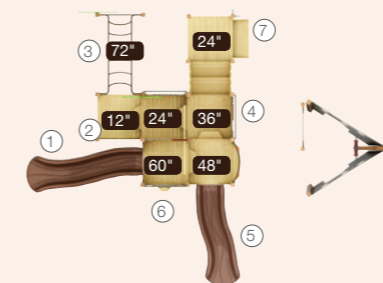

- ① 5ft Single Slide
- ② Balls & Flowers
- ③ Invert Arch Ladder
- ④ Counter Panel
- ⑤ 4ft Single Slide
- ⑥ Cymbals Panel
- ⑦ ADA Transfer Station





# NatureMAX Theme

The NatureMAX Theme is designed for all elements of fun. Climbers, slides, and movable elements paired with multiple themes provide endless options for entertainment. Wood style elements make these sets stand out in any environment, with a variety of nature-themed elements, you can customize.

The NatureMAX series supports children in exploring their surroundings more autonomously while using a wide range of activities. It also promotes the development of multiple skills in children through physical exercise.

All NatureMAX structures use high-end wood, which has its own anti-corrosion properties making it a solid and strong option. Wisdom's NatureMAX series promotes the development of multiple physical qualities of children through physical exercise. NatureMAX structures are built with 5" posts which allows the structure to be sturdy with more versatility.



## NATURE CASTLE | FL50CS-0001

Ages: 5-12

Fall Height: 132"

Use Zone: 69'x52'

Equipment Size: 57'x38'3"x25'4"

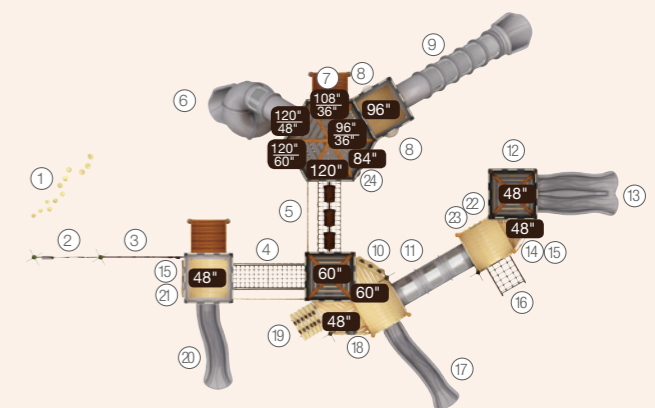

- ① Balance Stumps
- ② Net Climber-Leaf
- ③ Net Climber-Rock
- ④ Arch Net Bridge
- ⑤ Inclined Trunk Link
- ⑥ 10ft Spiral Tube Slide Left Turn
- ⑦ Growth Ring & Clock Panel
- ⑧ Bubble Window Panel
- ⑨ 8ft Straight Tube Slide
- ⑩ Kitchen Panel
- ⑪ Triple Crawl Tunnel
- ⑫ Train Gear Panel
- ⑬ 4ft Double Slide
- ⑭ Car Panel
- ⑮ Cannon Panel
- ⑯ 5ft Net Climber
- ⑰ 5ft Single Slide
- ⑱ 4ft Robinia Rock Climber
- ⑲ 4ft Single Slide
- ⑳ Drums Panel
- ㉑ Tic-Tac-Toe Panel
- ㉒ Crocodile Puzzle Panel
- ㉓ Counter Panel







## HOT PORTER | FL50CS-0003

Ages: 5-12  
 Fall Height: 48"  
 Use Zone: 44'x40'  
 Equipment Size: 31'2"x27'6"x17'4"

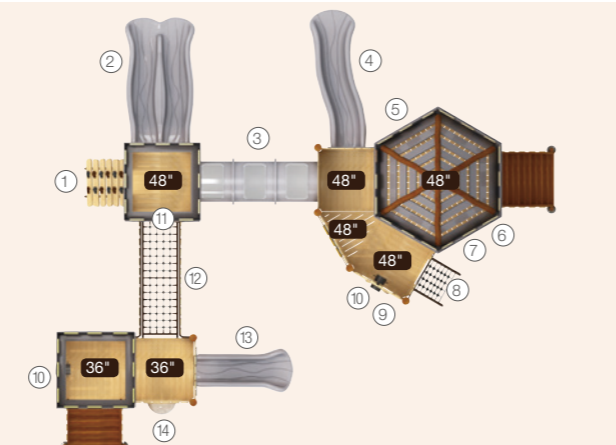

- ① 4ft Rock Climber
- ② 4ft Double Slide
- ③ 62" Crawl Tunnel
- ④ 4ft Single Slide
- ⑤ Harp Panel
- ⑥ Tic-Tac-Toe Panel (Below)
- ⑦ Growth Ring & Clock Panel (Above)
- ⑧ Counter Panel (Below)
- ⑨ 4ft Net Climber (Above)
- ⑩ Driving Panel (Below)
- ⑪ Drums Panel
- ⑫ Arch Net Bridge w/Metal Barrier
- ⑬ 3ft Single Slide
- ⑭ Bubble Window Panel

## DOVER FL50CS-0004

Ages: 5-12  
 Fall Height: 60"  
 Use Zone: 48'x33'  
 Equipment Size: 35'5"x20'3"x18'8"

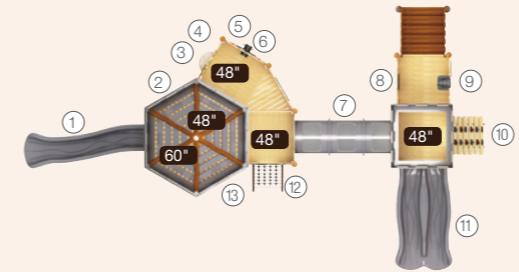

- ① 5ft Single Slide
- ② Growth Ring & Clock Panel
- ③ Tic-Tac-Toe Panel (Below)
- ④ Bubble Window Panel (Above)
- ⑤ Driving Panel (Below)
- ⑥ Cannon Panel (Above)
- ⑦ 62" Crawl Tunnel
- ⑧ Crocodile Puzzle Panel
- ⑨ Telescope Panel
- ⑩ 4ft Rock Climber
- ⑪ 4ft Double Slide
- ⑫ 4ft Net Climber
- ⑬ Harp Panel



## CORVIN FL50CS-0005

Ages: 5-12  
 Fall Height: 48"  
 Use Zone: 42'x30'  
 Equipment Size: 29'9"x17'7"x16'7"

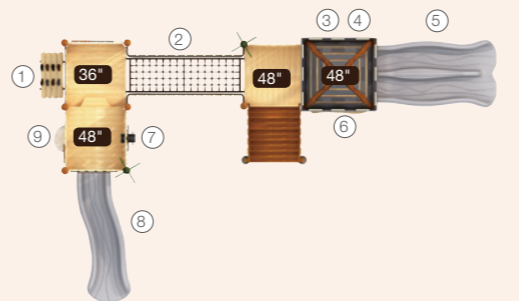

- ① 3ft Rock Climber
- ② Arch Net Bridge w/Metal Barrier
- ③ Tic-Tac-Toe Panel (Below)
- ④ Growth Ring & Clock Panel (Above)
- ⑤ 4ft Double Slide
- ⑥ Drums Panel
- ⑦ Cannon Panel
- ⑧ 4ft Single Slide
- ⑨ Bubble Window Panel





## MOUNTAINEER FL50TH-0005

Ages: 2-12  
Fall Height: 48"  
Use Zone: 44'x30'  
Equipment Size: 31'6"x17'3"x14'6"

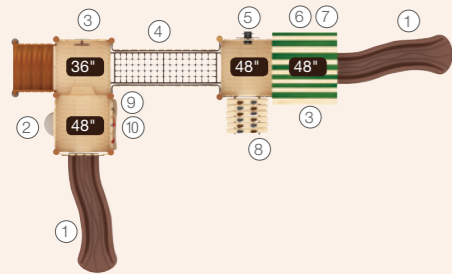

- ① 4ft Single Slide
- ② Bubble Window Panel
- ③ Car Panel
- ④ Arch Net Bridge
- ⑤ Cannon Panel
- ⑥ Train Gear Panel
- ⑦ Crocodile Puzzle Panel
- ⑧ 4ft Robinia Rock Climber
- ⑨ Growth Ring & Clock Panel (Above)
- ⑩ Drums Panel (Below)

## GLACIER EXPRESS FL50TH-0007

Ages: 2-12  
Fall Height: 48"  
Use Zone: 33'x27'  
Equipment Size: 20'8"x15'x15'

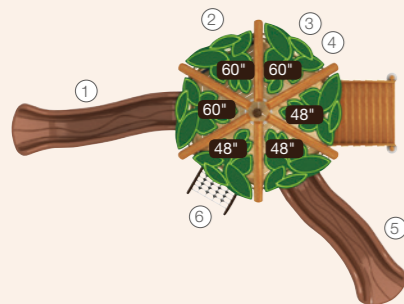

- ① 5ft Single Slide
- ② Train Gear Panel
- ③ Crocodile Puzzle Panel (Above)
- ④ Kitchen Panel (Below)
- ⑤ 4ft Single Slide
- ⑥ 4ft Net Climber

## NEPTUNE FF50PS-0005

Ages: 2-12  
Fall Height: 60"  
Use Zone: 46'x43'  
Equipment Size: 33'4"x30'1"x18'8"

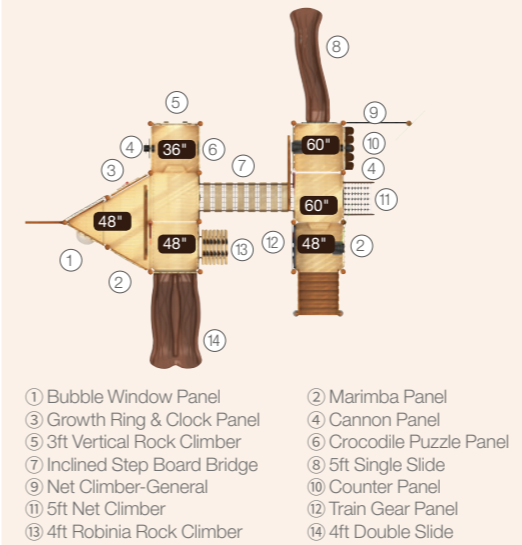

- ① Bubble Window Panel
- ② Marimba Panel
- ③ Growth Ring & Clock Panel
- ④ Cannon Panel
- ⑤ 3ft Vertical Rock Climber
- ⑥ Crocodile Puzzle Panel
- ⑦ Inclined Step Board Bridge
- ⑧ 5ft Single Slide
- ⑨ Net Climber-General
- ⑩ Counter Panel
- ⑪ 5ft Net Climber
- ⑫ Train Gear Panel
- ⑬ 4ft Robinia Rock Climber
- ⑭ 4ft Double Slide

## NOTORIOUS FF50PS-0006

Ages: 2-12  
Fall Height: 48"  
Use Zone: 34'x34'  
Equipment Size: 21'5"x21'6"x17'4"

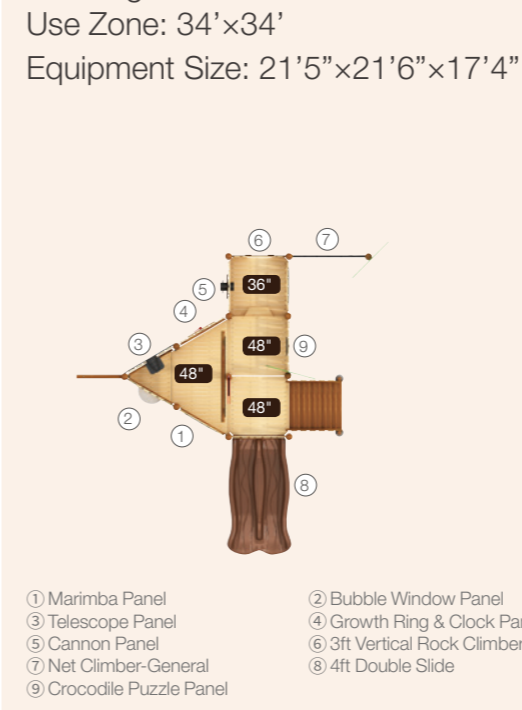

- ① Marimba Panel
- ② Bubble Window Panel
- ③ Telescope Panel
- ④ Growth Ring & Clock Panel
- ⑤ Cannon Panel
- ⑥ 3ft Vertical Rock Climber
- ⑦ Net Climber-General
- ⑧ 4ft Double Slide
- ⑨ Crocodile Puzzle Panel





# Slides



WP WM 3ft-5ft Single Slide



WP WM 4ft-5ft Double Slide



WP WM 3ft-8ft Sectional Slide



WP WM 5ft Sectional Slide 45° Right Turn



WP WM 5ft-7ft Triple Sectional Split Slide



WT WP WM 360° Spiral Slide



WP WM 5ft-10ft L-shape Tube Slide



WP WM 7ft-10ft S-shape Tube Slide



WP WM 3ft-10ft Straight Tube Slide



WP WM 8ft-10ft Spiral Tube Slide



WT 2ft Single Slide

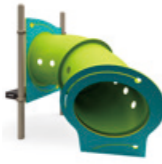

WP WM WT 2ft Inclined Crawl Tunnel Section Right Turn

# Climbers



WP WM 3ft-8ft Ribbon Climber



WP WM 3ft-8ft Snake Climber



WP WM 3ft-8ft Wing Climber



WP WM 3ft-5ft Arch Climber



WP WM 4ft-6ft Stair Climber



WP WM 4ft-6ft Leaf Climber



WP WM 3ft-6ft Leaf Step



WP WM 4ft-6ft Climbing Arc



WP WM 3ft-5ft Qubest Climber Entry



WP WM 4ft-6ft GEO Vertical Climber



WP WM 2ft-5ft Net Climber



WP WM 4ft Stump Climber



WP WM 3ft-6ft Pod Climber



WP WM 1ft-5ft Trunk Climber



WP WM WT 2ft/3ft Fish Climber

# Overhead Climbers



WP 90° Overhead Swing Rings



WP Zig Zag Overhead Rings



WP Invert Arch Ladder



WP WM 3ft-5ft Wave Climber



WP WM 4ft/5ft Rock Climber



WP WM 2ft-4ft PE Starfish Rock Climber



WP WM 2ft-4ft Tree wall Climber



WP WM 2ft-4ft Step and Stone Climber



WP WM 2ft-6ft Rockwall Climber



WP Deck to ground Whirler



WP WM Deck to ground Challenge Ladder

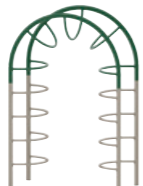

Up & Over Climber



Double Up & Over Climber



WP WM Toadstool Climber



WP WM Clover Step Bridge



WP 3ft/4ft Clover Steps



WP WM 4ft/5ft Arch O-Zone Climber



WP WM 3ft Rope Ladder



WT WP 2ft/3ft Arch Grab Climber



WT WP 2ft/3ft Belt Climber



WP WM 2ft-4ft Sail Climber



WP WM Jumbo Round Stepper



WP WM Freestanding Whirler



WP WM Horizontal Loop Ladder



WP WM Horizontal Lollipop Ladder



WP WM Round about Challenge



WP WM Lilly Pad Walk



WT 1ft/2ft WiseTOT Step



WT 1ft WiseTOT Ramp



WP WM Crescent Climber



WP WM Climbing Arc



WP WM Tri-Crawl Panel



WP WM Arch leaf Climber





WP WM Honeycomb Arch Climber  
 WP WM Sail Rock panel  
 WP WM 3ft-5ft PE Rock Climber  
 WP WM 3ft-5ft Frog hop Vertical Climber  
 WT Arch Climbing Panel  
 WP Vertical O-zone Climber

# Bridges



WP WM Arch Net Bridge  
 WM 8' Arch Net Bridge w/Metal Barrier  
 WP 6' Arch Net Bridge w/Rock Grain Barrier



WP Reverse Traverse  
 WP Orbs Climber  
 WP WM Horizontal Halo Climber  
 WP WM Inclined Net Climber  
 WP WM Honeycomb Net Climber  
 WP WM Tree Net Climber



WP 6' Arch Net Bridge w/Wood Grain Barrier  
 WM Trunk Link w/Metal Barrier  
 WM WP Plank Board Bridge  
 WP 6' Arch Plank board w/Rock Grain  
 WP 6' Step Board Bridge w/Wood Grain Barrier  
 WM Step Board Bridge w/Net Barrier

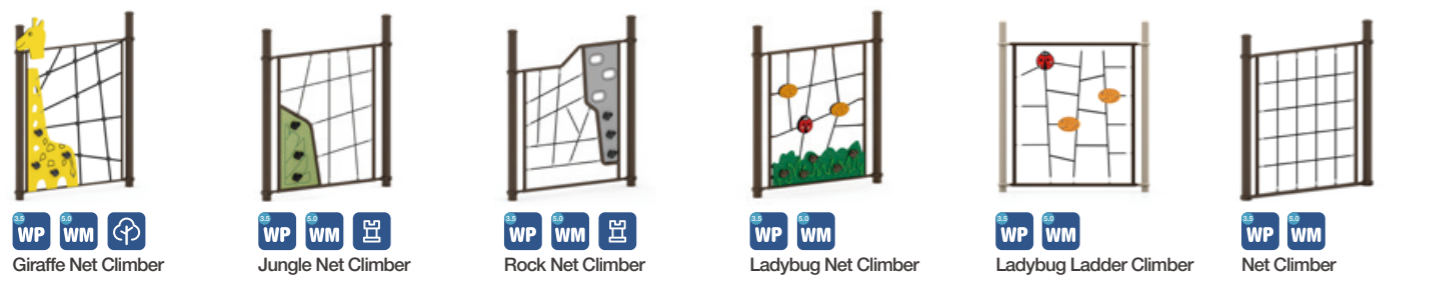

WP WM Giraffe Net Climber  
 WP WM Jungle Net Climber  
 WP WM Rock Net Climber  
 WP WM Ladybug Net Climber  
 WP WM Ladybug Ladder Climber  
 WP WM Net Climber



WP 90° Cloud Plank  
 WP WM Trunk Link w/Handrail  
 WP WM Trunk Link w/Metal Barrier  
 WP WM Straight Bridge w/Handrail  
 WP WM Straight Bridge w/Wood Grain Barrier  
 WP Straight Bridge w/Metal Barrier

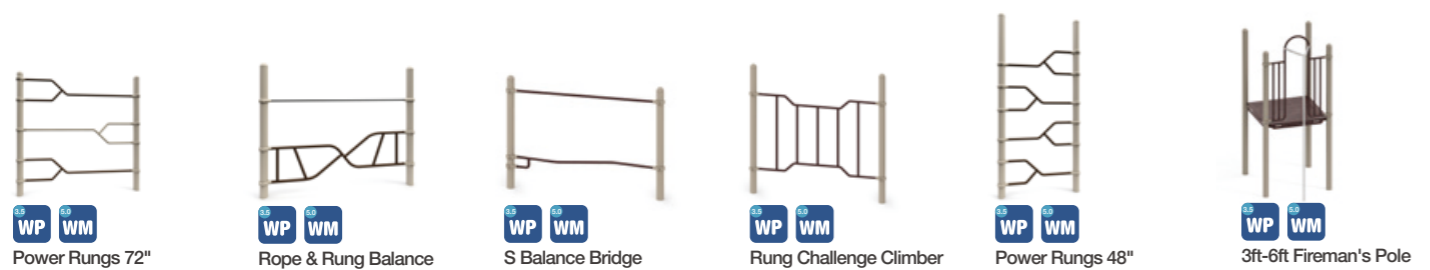

WP WM Power Rungs 72"  
 WP WM Rope & Rung Balance  
 WP WM S Balance Bridge  
 WP WM Rung Challenge Climber  
 WP WM Power Rungs 48"  
 WP WM 3ft-6ft Fireman's Pole



WP WM Arch Bridge  
 WP WM Straight Bridge  
 WP WM 1ft Straight Bridge w/Metal Barrier  
 WP WM 1ft Inclined Straight Bridge w/Metal Barrier  
 WP 1ft Inclined Flex Bridge  
 WP 2ft Belt Climber



WP WM 2ft Walk the plank Climber  
 WP WM 2ft Stump Steps  
 WP WM Deck to Deck Vertical Net Link  
 WP WM Deck to Deck Straight Link  
 WP WM Deck to Deck Arch Rock Climber  
 WP WM 5ft Hemisphere Climber

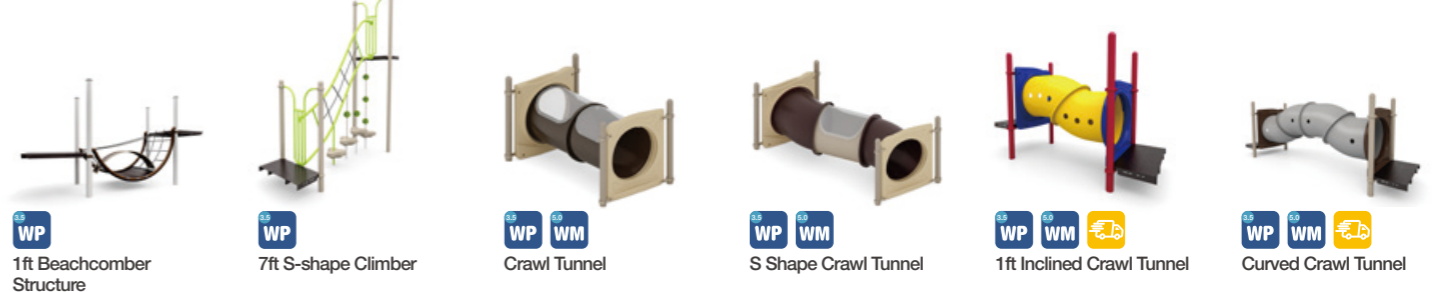

WP 1ft Beachcomber Structure  
 WP 7ft S-shape Climber  
 WP WM Crawl Tunnel  
 WP WM S Shape Crawl Tunnel  
 WP WM 1ft Inclined Crawl Tunnel  
 WP WM Curved Crawl Tunnel



WP 7ft Stanley the Spider



# Panels



WP Safety Panel



WP Panel for Large Activity Insert



WP Panel for Small Activity Insert



WP Decorative Panel (Shark)



WM Ship bow



WM Corsair - Panel for Large Activity Insert



WM Corsair-Panel for Small Activity Insert

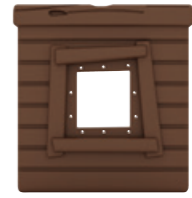

WM Corsair-Panel for Square Activity Insert

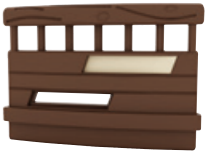

WM Starboard Panel



WP Panel for Large Square Activity Insert



WP WM Single Slide Hood



WP WM Double Slide Hood



WP Triple Slide Hood



WP Counter Panel



WP Castle theme - Panel for Large Square Activity Insert



WM Port Window Panel

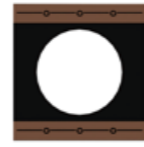

WM Ship Tube Slide hood



WM Ship Compass Worktop

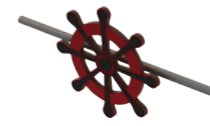

WM Ship Helm



WM Ship Wave Panel



WM Ship Flag



WP Panel for Large Activity Insert



WP City Gate Insert

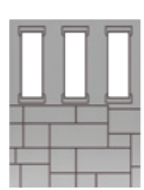

WP Barrier Insert



WM Castle-Battlement Panel for Big Activity Insert



WM Castle-Battlement Panel for Square Activity Insert



WM Castle-Battlement Panel for Window Activity Insert



WM Kitchen Panel



WM Ship - Barrel panel



WM Cottage Panel



WM Drums Panel



WP Sensory Green Window Worx



WP Sensory Blue Window Worx



WM Castle-Battlement Panel w/Rock



WM Castle-Battlement Panel w/Rock



WP Treehouse - Barrier Insert



WP TreeHouse Counter Panel



WP TreeHouse Snail Panel



WM Treehouse-Panel for Small Active Insert



WP Sensory Red Window Worx



WP Sensory Yellow Window Worx



WP Balcony Deck Barrier w/ Steering Wheel

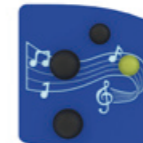

WP PE Leaf Theme Music Panel



WP PE Leaf Theme - Safety Panel



WP Marimba Panel

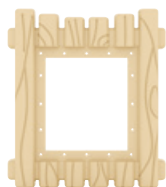

WM Treehouse-Panel for Square Activity Insert



WM Panel for Large Activity Insert (Tan)



WM Treehouse - PE Tube Slide Hood



WM Tree Hole Entry



WP Corsair Doorway Panel (Brown)



WP Corsair Panel for Large Activity Insert (Tan)



WP Galaxy panel



WM Driver Half Panel

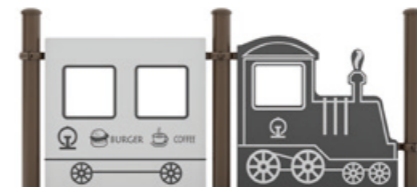

WM Atlanta - Train Game Panel



WT Safety Panel



WT Bubble Window Panel



WP Boston - Corsair Barrier Panel (Brown)



WP Boston - Corsair Entry Panel



WP Boston - Corsair Counter Panel



WP Boston - Corsair Prow Panel (Brown)



WP Rooftop Flag Panel



WP Boston - Corsair Sail Panel



WT WiseTOT Music Panel



WT WiseTOT Height Measurer Panel



WT WiseTOT Elephant Panel



WT WiseTOT Safety Panel



WT WiseTOT Turntable Panel



WT WiseTOT Arch Panel



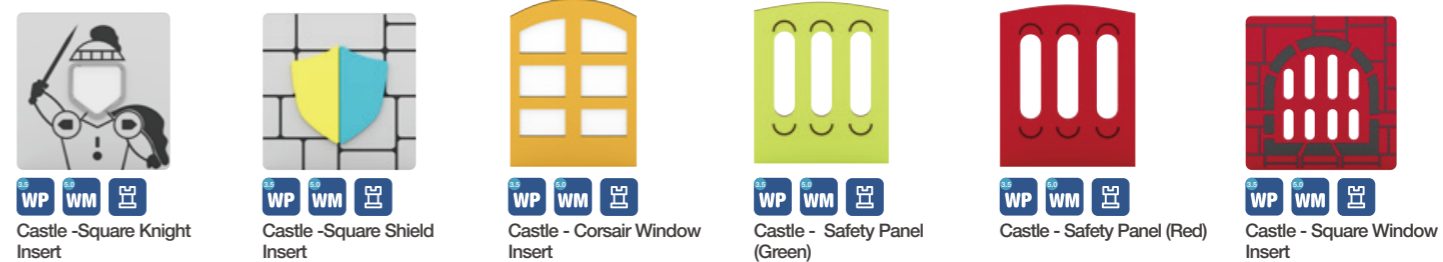
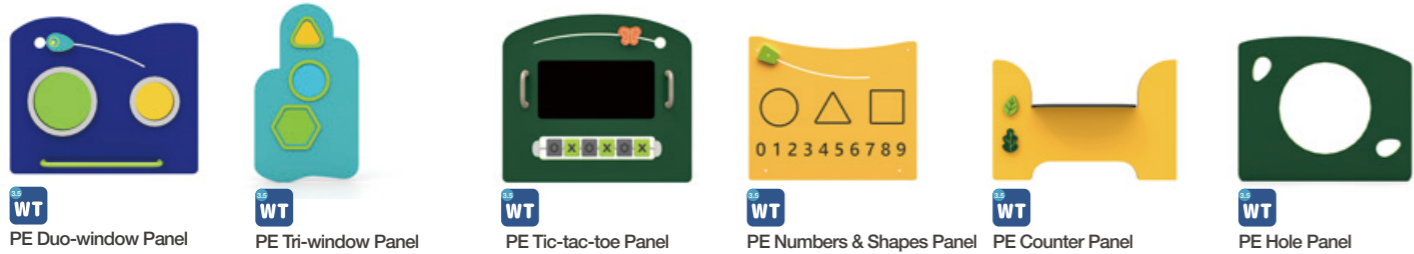

## Theme panels

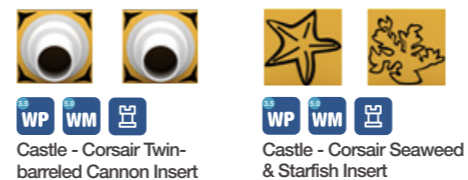

## Activity panels

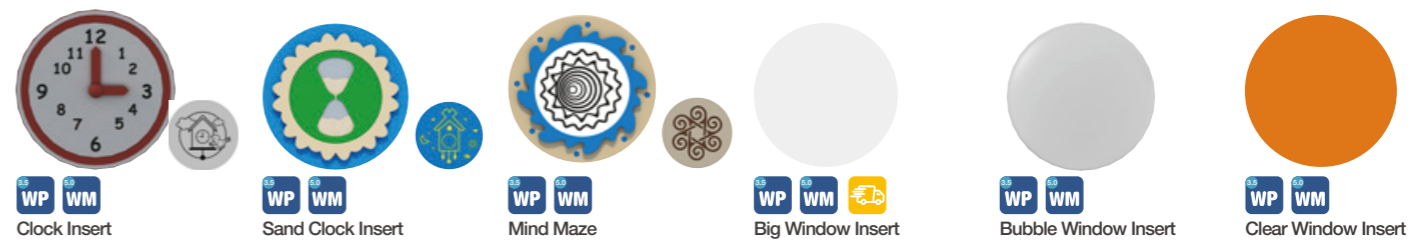
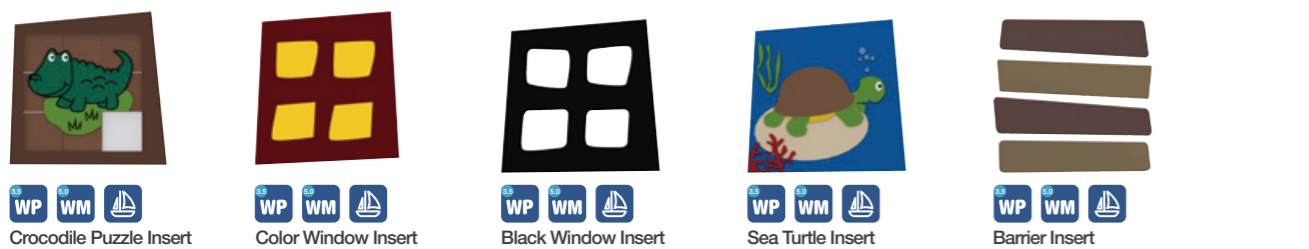

## Theme panels

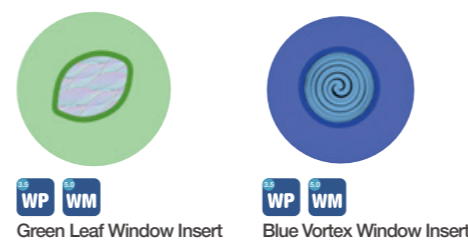





Small Growth Ring & Clock Insert



Small Crocodile Puzzle Insert



Beads & Cups Insert



Maze Insert



Gabble Leaf Roof



Leaf Roof



Two Post Leaf Roof



Single Post Leaf Roof



Two-post Roof



Arch Post Triangle Shade



Puzzle Insert



Small Window Insert



Small Cannon Insert



Tic-Tac-Toe Insert



Split - Tier Roof



Gabble Roof

# Roofs



Square Leaf Roof



Hex Leaf Roof



Treehouse Gable Roof

# The Worx

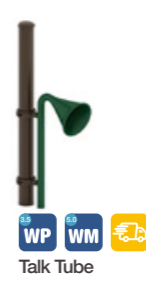

Talk Tube



Rain Wheel



Bongo



Treehouse leaf Roof



Treehouse - Half-hex Leaf Roof



Treehouse split level hex leaf



Treehouse - Gable Roof w/Batten



Treehouse - Gable Roof w/Tile



Pyramid Roof



Saddle Seat



PE Stool



Rock and Roll ON



Sling Seat



Clover Seat



Palm Topper



Boston Castle - Hex Roof



Boston Castle - Square Roof



Castle - Battlement blockwall



Castle - Brick hex roof



Castle - Square Brick roof



Castle - battlement Stonewall



Pine Tree Topper



Grove Topper



Game Table



Leaf Table



Belt Seat



Wisetot Push and play

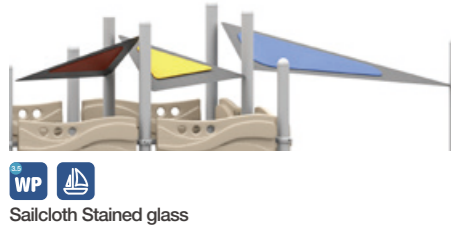

Sailcloth Stained glass

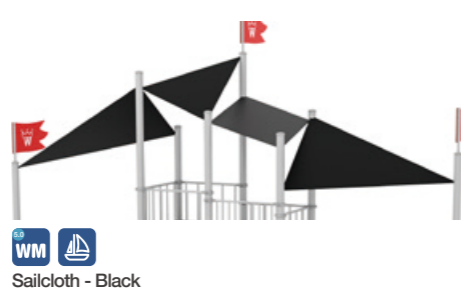

Sailcloth - Black



12.5ft x11ft Hex Shade Fabric



12ft x12ft Square Shade Fabric



PE Turntable



Bear Step





POWDER-COATED METAL COLORS

SHADE FABRIC COLORS

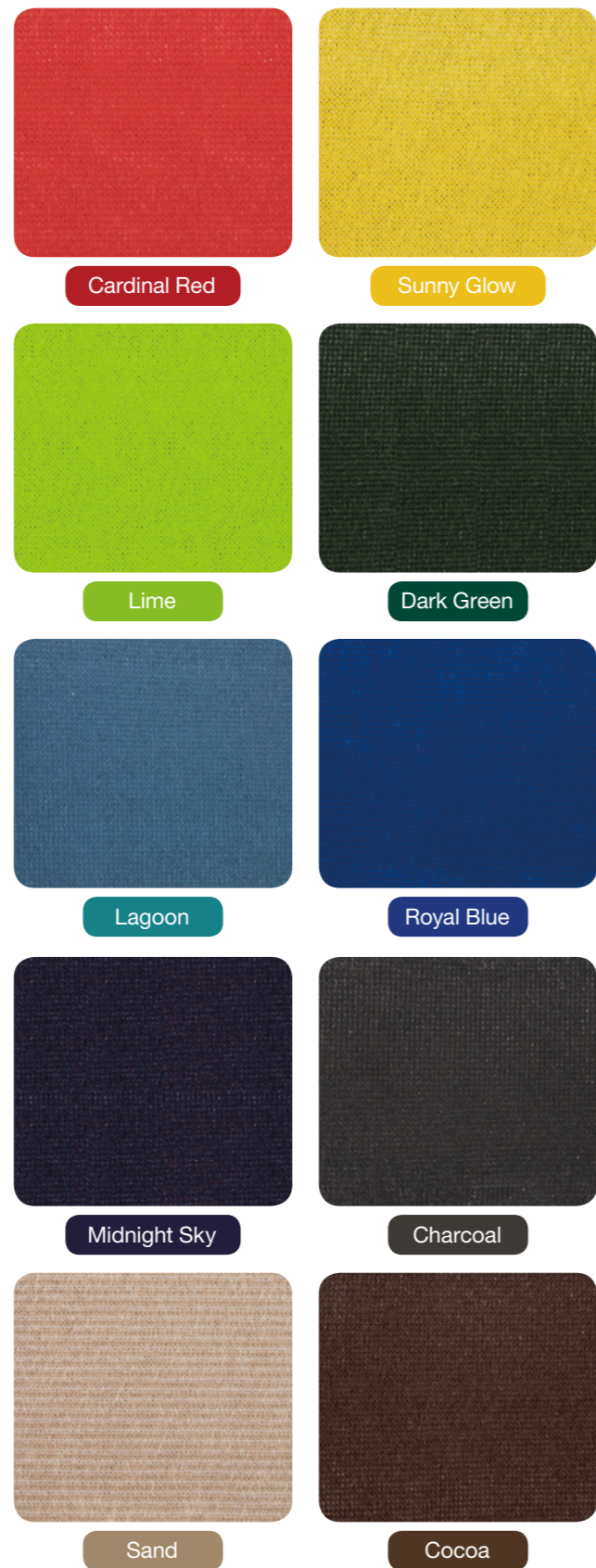

HDPE PANEL COLORS



ROTATIONAL PLASTIC COLORS





# COLOR SCHEMES

Cancun



Flannel



Abundance



Beachy



Limelight



Shine



Power



Bright Side



Mystery



Natural



Elemental



NatureBrite



Lively



Nostalgia



Polar



Retro



Spring



Primary



North



Royalty



Prospective





10 QSWP-350002N00 SHININ BRIGHT  
10 QSWP-350002P00 SHININ BRIGHT  
10 QSWP-350002N11 SHININ BRIGHT  
10 QSWP-350002P11 SHININ BRIGHT  
10 QSWP-350002N12 SHININ BRIGHT  
10 QSWP-350002P12 SHININ BRIGHT  
10 QSWP-350002N13 SHININ BRIGHT  
10 QSWP-350002P13 SHININ BRIGHT  
11 QSWP-350001N00 MONKEY PLAY  
11 QSWP-350001P00 MONKEY PLAY  
11 QSWP-350001N11 MONKEY PLAY  
11 QSWP-350001P11 MONKEY PLAY  
11 QSWP-350001N12 MONKEY PLAY  
11 QSWP-350001P12 MONKEY PLAY  
11 QSWP-350001N13 MONKEY PLAY  
11 QSWP-350001P13 MONKEY PLAY  
12 QSWP-350012N00 CHARLESTON  
12 QSWP-350012P00 CHARLESTON  
12 QSWP-350012N07 CHARLESTON  
12 QSWP-350012P07 CHARLESTON  
12 QSWP-350012N06 CHARLESTON  
12 QSWP-350012P06 CHARLESTON  
13 QSWP-350016N00 NORTHERN PLACE  
13 QSWP-350016P00 NORTHERN PLACE  
13 QSWP-350016N11 NORTHERN PLACE  
13 QSWP-350016P11 NORTHERN PLACE  
13 QSWP-350016N12 NORTHERN PLACE  
13 QSWP-350016P12 NORTHERN PLACE  
13 QSWP-350016N13 NORTHERN PLACE  
13 QSWP-350016P13 NORTHERN PLACE  
14 QSWP-350009N00 AUGUSTA  
14 QSWP-350009P00 AUGUSTA  
14 QSWP-350009N11 AUGUSTA  
14 QSWP-350009P11 AUGUSTA  
14 QSWP-350009N12 AUGUSTA  
14 QSWP-350009P12 AUGUSTA  
14 QSWP-350009N13 AUGUSTA  
14 QSWP-350009P13 AUGUSTA  
15 QSWP-350008N00 BUGALOO  
15 QSWP-350008P00 BUGALOO  
15 QSWP-350008N32 BUGALOO  
15 QSWP-350008P32 BUGALOO  
15 QSWP-350008N33 BUGALOO  
15 QSWP-350008P33 BUGALOO  
16 QSWP-350028N00 SADIE CREEK  
16 QSWP-350028P00 SADIE CREEK  
16 QSWP-350028N11 SADIE CREEK  
16 QSWP-350028P11 SADIE CREEK  
16 QSWP-350028N12 SADIE CREEK  
16 QSWP-350028P12 SADIE CREEK  
16 QSWP-350028N13 SADIE CREEK  
16 QSWP-350028P13 SADIE CREEK  
17 QSWP-350025N00 SPEED RACER  
17 QSWP-350025P00 SPEED RACER  
17 QSWP-350025N11 SPEED RACER  
17 QSWP-350025P11 SPEED RACER  
17 QSWP-350025N12 SPEED RACER  
17 QSWP-350025P12 SPEED RACER  
17 QSWP-350025N13 SPEED RACER  
17 QSWP-350025P13 SPEED RACER  
18 QSWP-350059N00 PALM SPRINGS  
18 QSWP-350059P00 PALM SPRINGS  
18 QSWP-350059N06 PALM SPRINGS  
18 QSWP-350059P06 PALM SPRINGS  
18 QSWP-350059N07 PALM SPRINGS  
18 QSWP-350059P07 PALM SPRINGS  
19 QSWP-350046N00 ROCKY  
19 QSWP-350046P00 ROCKY  
19 QSWP-350046N32 ROCKY  
19 QSWP-350046P32 ROCKY  
19 QSWP-350046N33 ROCKY  
19 QSWP-350046P33 ROCKY  
20 QSWP-350045N00 JANIE  
20 QSWP-350045P00 JANIE  
20 QSWP-350045N11 JANIE  
20 QSWP-350045P11 JANIE  
20 QSWP-350045N12 JANIE  
20 QSWP-350045P12 JANIE  
20 QSWP-350045N13 JANIE  
20 QSWP-350045P13 JANIE  
21 QSWP-350021N00 AHOY MATE  
21 QSWP-350021P00 AHOY MATE  
21 QSWP-350021N11 AHOY MATE  
21 QSWP-350021P11 AHOY MATE  
21 QSWP-350021N12 AHOY MATE  
21 QSWP-350021P12 AHOY MATE  
21 QSWP-350021N13 AHOY MATE  
21 QSWP-350021P13 AHOY MATE  
22 QSWP-350020N00 CAROUSEL  
22 QSWP-350020P00 CAROUSEL  
22 QSWP-350020N11 CAROUSEL  
22 QSWP-350020P11 CAROUSEL  
22 QSWP-350020N12 CAROUSEL  
22 QSWP-350020P12 CAROUSEL  
22 QSWP-350020N13 CAROUSEL  
22 QSWP-350020P13 CAROUSEL

23 QSWP-350005N00 SHADY PINES  
23 QSWP-350005P00 SHADY PINES  
23 QSWP-350005N11 SHADY PINES  
23 QSWP-350005P11 SHADY PINES  
23 QSWP-350005N12 SHADY PINES  
23 QSWP-350005P12 SHADY PINES  
23 QSWP-350005N13 SHADY PINES  
23 QSWP-350005P13 SHADY PINES  
24 QSWP-350023N00 OLYMPIA  
24 QSWP-350023P00 OLYMPIA  
24 QSWP-350023N11 OLYMPIA  
24 QSWP-350023P11 OLYMPIA  
24 QSWP-350023N12 OLYMPIA  
24 QSWP-350023P12 OLYMPIA  
24 QSWP-350023N13 OLYMPIA  
24 QSWP-350023P13 OLYMPIA  
25 QSWP-350019N00 HARPERS PLACE  
25 QSWP-350019P00 HARPERS PLACE  
25 QSWP-350019N11 HARPERS PLACE  
25 QSWP-350019P11 HARPERS PLACE  
25 QSWP-350019N12 HARPERS PLACE  
25 QSWP-350019P12 HARPERS PLACE  
25 QSWP-350019N33 HARPERS PLACE  
25 QSWP-350019P33 HARPERS PLACE  
26 QSWP-350006N00 TIMBER TRACKS  
26 QSWP-350006P00 TIMBER TRACKS  
26 QSWP-350006N11 TIMBER TRACKS  
26 QSWP-350006P11 TIMBER TRACKS  
26 QSWP-350006N12 TIMBER TRACKS  
26 QSWP-350006P12 TIMBER TRACKS  
26 QSWP-350006N13 TIMBER TRACKS  
26 QSWP-350006P13 TIMBER TRACKS  
27 QSWP-350003N00 LEAFY TIME  
27 QSWP-350003P00 LEAFY TIME  
27 QSWP-350003N11 LEAFY TIME  
27 QSWP-350003P11 LEAFY TIME  
27 QSWP-350003N12 LEAFY TIME  
27 QSWP-350003P12 LEAFY TIME  
27 QSWP-350003N13 LEAFY TIME  
27 QSWP-350003P13 LEAFY TIME  
28 QSWP-350015N00 ALL POINTS  
28 QSWP-350015P00 ALL POINTS  
28 QSWP-350015N11 ALL POINTS  
28 QSWP-350015P11 ALL POINTS  
28 QSWP-350015N12 ALL POINTS  
28 QSWP-350015P12 ALL POINTS  
28 QSWP-350015N13 ALL POINTS  
28 QSWP-350015P13 ALL POINTS  
29 QSWP-350026N00 JUNGLE PLAY  
29 QSWP-350026P00 JUNGLE PLAY  
29 QSWP-350026N11 JUNGLE PLAY  
29 QSWP-350026P11 JUNGLE PLAY  
29 QSWP-350026N12 JUNGLE PLAY  
29 QSWP-350026P12 JUNGLE PLAY  
29 QSWP-350026N13 JUNGLE PLAY  
29 QSWP-350026P13 JUNGLE PLAY  
30 QSWP-350027N00 MIGHTY MAGIC  
30 QSWP-350027P00 MIGHTY MAGIC  
30 QSWP-350027N11 MIGHTY MAGIC  
30 QSWP-350027P11 MIGHTY MAGIC  
30 QSWP-350027N12 MIGHTY MAGIC  
30 QSWP-350027P12 MIGHTY MAGIC  
30 QSWP-350027N13 MIGHTY MAGIC  
30 QSWP-350027P13 MIGHTY MAGIC  
31 QSWP-350022N00 DENVER  
31 QSWP-350022P00 DENVER  
31 QSWP-350022N11 DENVER  
31 QSWP-350022P11 DENVER  
31 QSWP-350022N12 DENVER  
31 QSWP-350022P12 DENVER  
31 QSWP-350022N13 DENVER  
31 QSWP-350022P13 DENVER  
32 QSWP-350014N00 FALCON RIDGE  
32 QSWP-350014P00 FALCON RIDGE  
32 QSWP-350014N11 FALCON RIDGE  
32 QSWP-350014P11 FALCON RIDGE  
32 QSWP-350014N12 FALCON RIDGE  
32 QSWP-350014P12 FALCON RIDGE  
32 QSWP-350014N13 FALCON RIDGE  
32 QSWP-350014P13 FALCON RIDGE  
33 QSWP-350044N00 DAVIS GRAY  
33 QSWP-350044P00 DAVIS GRAY  
33 QSWP-350044N11 DAVIS GRAY  
33 QSWP-350044P11 DAVIS GRAY  
33 QSWP-350044N12 DAVIS GRAY  
33 QSWP-350044P12 DAVIS GRAY  
33 QSWP-350044N13 DAVIS GRAY  
33 QSWP-350044P13 DAVIS GRAY  
34 QSWP-350018N00 MOUNT RAINIER  
34 QSWP-350018P00 MOUNT RAINIER  
34 QSWP-350018N11 MOUNT RAINIER  
34 QSWP-350018P11 MOUNT RAINIER  
34 QSWP-350018N12 MOUNT RAINIER  
34 QSWP-350018P12 MOUNT RAINIER  
34 QSWP-350018N13 MOUNT RAINIER  
34 QSWP-350018P13 MOUNT RAINIER

35 QSWP-350061N00 KENAI  
35 QSWP-350061P00 KENAI  
35 QSWP-350061N11 KENAI  
35 QSWP-350061P11 KENAI  
35 QSWP-350061N12 KENAI  
35 QSWP-350061P12 KENAI  
35 QSWP-350061N13 KENAI  
35 QSWP-350061P13 KENAI  
36 QSWP-350062N00 POETER  
36 QSWP-350062P00 POETER  
36 QSWP-350062N11 POETER  
36 QSWP-350062P11 POETER  
36 QSWP-350062N12 POETER  
36 QSWP-350062P12 POETER  
36 QSWP-350062N13 POETER  
36 QSWP-350062P13 POETER  
37 QSWP-350063N00 TIMBER RIDGE  
37 QSWP-350063P00 TIMBER RIDGE  
37 QSWP-350063N11 TIMBER RIDGE  
37 QSWP-350063P11 TIMBER RIDGE  
37 QSWP-350063N12 TIMBER RIDGE  
37 QSWP-350063P12 TIMBER RIDGE  
37 QSWP-350063N13 TIMBER RIDGE  
37 QSWP-350063P13 TIMBER RIDGE  
38 QSWP-350064N00 WILD RUN  
38 QSWP-350064P00 WILD RUN  
38 QSWP-350064N11 WILD RUN  
38 QSWP-350064P11 WILD RUN  
38 QSWP-350064N12 WILD RUN  
38 QSWP-350064P12 WILD RUN  
38 QSWP-350064N13 WILD RUN  
38 QSWP-350064P13 WILD RUN  
39 QSWP-350065N00 GALENA  
39 QSWP-350065P00 GALENA  
39 QSWP-350065N32 GALENA  
39 QSWP-350065P32 GALENA  
39 QSWP-350065N33 GALENA  
39 QSWP-350065P33 GALENA  
40 QSWP-350066N00 SKYLER  
40 QSWP-350066P00 SKYLER  
40 QSWP-350066N32 SKYLER  
40 QSWP-350066P32 SKYLER  
40 QSWP-350066N33 SKYLER  
40 QSWP-350066P33 SKYLER  
41 QSWP-350067N00 MCKINLEY  
41 QSWP-350067P00 MCKINLEY  
41 QSWP-350067N11 MCKINLEY  
41 QSWP-350067P11 MCKINLEY  
41 QSWP-350067N12 MCKINLEY  
41 QSWP-350067P12 MCKINLEY  
41 QSWP-350067N13 MCKINLEY  
41 QSWP-350067P13 MCKINLEY  
42 QSWP-350068N00 FAIRBANKS  
42 QSWP-350068P00 FAIRBANKS  
42 QSWP-350068N11 FAIRBANKS  
42 QSWP-350068P11 FAIRBANKS  
42 QSWP-350068N12 FAIRBANKS  
42 QSWP-350068P12 FAIRBANKS  
42 QSWP-350068N13 FAIRBANKS  
42 QSWP-350068P13 FAIRBANKS  
43 QSWP-350069N00 NONNY  
43 QSWP-350069P00 NONNY  
43 QSWP-350069N11 NONNY  
43 QSWP-350069P11 NONNY  
43 QSWP-350069N12 NONNY  
43 QSWP-350069P12 NONNY  
43 QSWP-350069N13 NONNY  
43 QSWP-350069P13 NONNY  
44 QSWP-350011N00 BONGO PLAY  
44 QSWP-350011P00 BONGO PLAY  
44 QSWP-350011N11 BONGO PLAY  
44 QSWP-350011P11 BONGO PLAY  
44 QSWP-350011N12 BONGO PLAY  
44 QSWP-350011P12 BONGO PLAY  
44 QSWP-350011N13 BONGO PLAY  
44 QSWP-350011P13 BONGO PLAY  
45 QSWP-350040N00 JURASSIC  
45 QSWP-350040P00 JURASSIC  
45 QSWP-350040N11 JURASSIC  
45 QSWP-350040P11 JURASSIC  
45 QSWP-350040N12 JURASSIC  
45 QSWP-350040P12 JURASSIC  
45 QSWP-350040N13 JURASSIC  
45 QSWP-350040P13 JURASSIC  
46 QSWP-350041N00 MINNIE  
46 QSWP-350041P00 MINNIE  
46 QSWP-350041N11 MINNIE  
46 QSWP-350041P11 MINNIE  
46 QSWP-350041N12 MINNIE  
46 QSWP-350041P12 MINNIE  
46 QSWP-350041N13 MINNIE  
46 QSWP-350041P13 MINNIE  
47 QSWP-350042N00 BOBBIE  
47 QSWP-350042P00 BOBBIE  
47 QSWP-350042N11 BOBBIE  
47 QSWP-350042P11 BOBBIE

47 QSWP-350042N12 BOBBIE  
47 QSWP-350042P12 BOBBIE  
47 QSWP-350042N13 BOBBIE  
47 QSWP-350042P13 BOBBIE  
48 QSWP-350058N00 WINDER  
48 QSWP-350058P00 WINDER  
48 QSWP-350058N32 WINDER  
48 QSWP-350058P32 WINDER  
48 QSWP-350058N33 WINDER  
48 QSWP-350058P33 WINDER  
49 QSWP-350010N00 PLAY TIME  
49 QSWP-350010P00 PLAY TIME  
49 QSWP-350010N11 PLAY TIME  
49 QSWP-350010P11 PLAY TIME  
49 QSWP-350010N12 PLAY TIME  
49 QSWP-350010P12 PLAY TIME  
49 QSWP-350010N13 PLAY TIME  
49 QSWP-350010P13 PLAY TIME  
50 QSWP-350060N00 ZAK  
50 QSWP-350060P00 ZAK  
50 QSWP-350060N11 ZAK  
50 QSWP-350060P11 ZAK  
50 QSWP-350060N12 ZAK  
50 QSWP-350060P12 ZAK  
50 QSWP-350060N13 ZAK  
50 QSWP-350060P13 ZAK  
51 QSWP-350004N00 SUNNY DAYS  
51 QSWP-350004P00 SUNNY DAYS  
51 QSWP-350004N11 SUNNY DAYS  
51 QSWP-350004P11 SUNNY DAYS  
51 QSWP-350004N12 SUNNY DAYS  
51 QSWP-350004P12 SUNNY DAYS  
51 QSWP-350004N13 SUNNY DAYS  
51 QSWP-350004P13 SUNNY DAYS  
52 QSWP-350056N00 TURTLE ISLAND  
52 QSWP-350056P00 TURTLE ISLAND  
52 QSWP-350056N06 TURTLE ISLAND  
52 QSWP-350056P06 TURTLE ISLAND  
52 QSWP-350056N07 TURTLE ISLAND  
52 QSWP-350056P07 TURTLE ISLAND  
53 QSWP-350017N00 SUNNY STACK  
53 QSWP-350017P00 SUNNY STACK  
53 QSWP-350017N11 SUNNY STACK  
53 QSWP-350017P11 SUNNY STACK  
53 QSWP-350017N12 SUNNY STACK  
53 QSWP-350017P12 SUNNY STACK  
53 QSWP-350017N13 SUNNY STACK  
53 QSWP-350017P13 SUNNY STACK  
54 QSWP-350043N00 JEREMY  
54 QSWP-350043P00 JEREMY  
54 QSWP-350043N11 JEREMY  
54 QSWP-350043P11 JEREMY  
54 QSWP-350043N12 JEREMY  
54 QSWP-350043P12 JEREMY  
54 QSWP-350043N13 JEREMY  
54 QSWP-350043P13 JEREMY  
54 QSWP-350043N14 JEREMY  
54 QSWP-350043P14 JEREMY  
56 QSWP-350037N00 MEMPHIS  
56 QSWP-350037P00 MEMPHIS  
56 QSWP-350037N32 MEMPHIS  
56 QSWP-350037P32 MEMPHIS  
56 QSWP-350037N33 MEMPHIS  
56 QSWP-350037P33 MEMPHIS  
58 QSWP-350038N00 ATLANTA  
58 QSWP-350038P00 ATLANTA  
58 QSWP-350038N32 ATLANTA  
58 QSWP-350038P32 ATLANTA  
58 QSWP-350038N33 ATLANTA  
58 QSWP-350038P33 ATLANTA  
59 QSWP-350038N34 ATLANTA  
59 QSWP-350038P34 ATLANTA  
60 QSWP-350038N35 ATLANTA  
60 QSWP-350038P35 ATLANTA  
61 QSWP-350038N36 ATLANTA  
61 QSWP-350038P36 ATLANTA  
61 QSWP-350038N37 ATLANTA  
61 QSWP-350038P37 ATLANTA  
61 QSWP-350038N38 ATLANTA  
61 QSWP-350038P38 ATLANTA  
62 QSWP-350038N39 ATLANTA  
62 QSWP-350038P39 ATLANTA  
63 QSWP-350038N40 ATLANTA  
63 QSWP-350038P40 ATLANTA  
63 QSWP-350038N41 ATLANTA  
63 QSWP-350038P41 ATLANTA  
63 QSWP-350038N42 ATLANTA  
63 QSWP-350038P42 ATLANTA  
63 QSWP-350038N43 ATLANTA  
63 QSWP-350038P43 ATLANTA  
63 QSWP-350038N44 ATLANTA  
63 QSWP-350038P44 ATLANTA  
63 QSWP-350038N45 ATLANTA  
63 QSWP-350038P45 ATLANTA  
63 QSWP-350038N46 ATLANTA  
63 QSWP-350038P46 ATLANTA  
63 QSWP-350038N47 ATLANTA  
63 QSWP-350038P47 ATLANTA  
63 QSWP-350038N48 ATLANTA  
63 QSWP-350038P48 ATLANTA  
63 QSWP-350038N49 ATLANTA  
63 QSWP-350038P49 ATLANTA  
63 QSWP-350038N50 ATLANTA  
63 QSWP-350038P50 ATLANTA  
64 QSWP-350047N00 SEQUOIA  
64 QSWP-350047P00 SEQUOIA  
64 QSWP-350047N11 SEQUOIA  
64 QSWP-350047P11 SEQUOIA  
64 QSWP-350047N12 SEQUOIA  
64 QSWP-350047P12 SEQUOIA  
64 QSWP-350047N13 SEQUOIA  
64 QSWP-350047P13 SEQUOIA



65	QSWP-350052N00	GALILEO
65	QSWP-350052P00	GALILEO
65	QSWP-350052N06	GALILEO
65	QSWP-350052P06	GALILEO
65	QSWP-350052N07	GALILEO
65	QSWP-350052P07	GALILEO
66	QSWP-350054N00	HIDEOUT
66	QSWP-350054P00	HIDEOUT
66	QSWP-350054N06	HIDEOUT
66	QSWP-350054P06	HIDEOUT
66	QSWP-350054N07	HIDEOUT
66	QSWP-350054P07	HIDEOUT
67	QSWP-350055N00	ASHTON
67	QSWP-350055P00	ASHTON
67	QSWP-350055N11	ASHTON
67	QSWP-350055P11	ASHTON
67	QSWP-350055N12	ASHTON
67	QSWP-350055P12	ASHTON
67	QSWP-350055N13	ASHTON
67	QSWP-350055P13	ASHTON
68	QSWP-350048N00	WORLD TRAVELER
68	QSWP-350048P00	WORLD TRAVELER
68	QSWP-350048N06	WORLD TRAVELER
68	QSWP-350048P06	WORLD TRAVELER
68	QSWP-350048N07	WORLD TRAVELER
68	QSWP-350048P07	WORLD TRAVELER
69	QSWP-350007N00	YESTERYEARS
69	QSWP-350007P00	YESTERYEARS
69	QSWP-350007N11	YESTERYEARS
69	QSWP-350007P11	YESTERYEARS
69	QSWP-350007N12	YESTERYEARS
69	QSWP-350007P12	YESTERYEARS
69	QSWP-350007N13	YESTERYEARS
69	QSWP-350007P13	YESTERYEARS
70	QSWP-350024N00	KIDZ CORNER
70	QSWP-350024P00	KIDZ CORNER
70	QSWP-350024N11	KIDZ CORNER
70	QSWP-350024P11	KIDZ CORNER
70	QSWP-350024N12	KIDZ CORNER
70	QSWP-350024P12	KIDZ CORNER
70	QSWP-350024N13	KIDZ CORNER
70	QSWP-350024P13	KIDZ CORNER
71	QSWP-350051N00	BITTERROOT
71	QSWP-350051P00	BITTERROOT
71	QSWP-350051N11	BITTERROOT
71	QSWP-350051P11	BITTERROOT
71	QSWP-350051N12	BITTERROOT
71	QSWP-350051P12	BITTERROOT
71	QSWP-350051N13	BITTERROOT
71	QSWP-350051P13	BITTERROOT
72	QSWP-350049N00	FALKVILLE
72	QSWP-350049P00	FALKVILLE
72	QSWP-350049N11	FALKVILLE
72	QSWP-350049P11	FALKVILLE
72	QSWP-350049N12	FALKVILLE
72	QSWP-350049P12	FALKVILLE
72	QSWP-350049N13	FALKVILLE
72	QSWP-350049P13	FALKVILLE
73	QSWP-350053N00	TIME FLYER
73	QSWP-350053P00	TIME FLYER
73	QSWP-350053N11	TIME FLYER
73	QSWP-350053P11	TIME FLYER
73	QSWP-350053N12	TIME FLYER
73	QSWP-350053P12	TIME FLYER
73	QSWP-350053N13	TIME FLYER
73	QSWP-350053P13	TIME FLYER
74	QSWP-350050N00	ASTER
74	QSWP-350050P00	ASTER
74	QSWP-350050N11	ASTER
74	QSWP-350050P11	ASTER
74	QSWP-350050N12	ASTER
74	QSWP-350050P12	ASTER
74	QSWP-350050N13	ASTER
74	QSWP-350050P13	ASTER
75	QSWP-350013N00	PIKES PEAK
75	QSWP-350013P00	PIKES PEAK
75	QSWP-350013N32	PIKES PEAK
75	QSWP-350013P32	PIKES PEAK
75	QSWP-350013N33	PIKES PEAK
75	QSWP-350013P33	PIKES PEAK
75	QSBS35CS-0011	QUEEN THYME
76	QSAT50TH-0008-NG	LEAVES OF THYME
78	QSFS-CL0017N	TRAIL BLAZER
78	QSFS-CL0017P	TRAIL BLAZER
79	QSFS-CL0013N	DALLAS
79	QSFS-CL0013P	DALLAS
80	QSFS-CL0016N	QUICK STEP
80	QSFS-CL0016P	QUICK STEP
81	QSFS-CL0015N	SPIDER
81	QSFS-CL0015P	SPIDER
81	QSFS-CL0014N	THE CHALLENGER
81	QSFS-CL0014P	THE CHALLENGER
82	QSFS-CL0026N	MOOSE TRACKS
82	QSFS-CL0018N	LUCKY CLIMBER
84	QSAS-350801	ARCH POST SWING
84	QSSPS-0801-TS	BUCKET TREE SWING

84	QSSPS-0801-1A	SINGLE POST SWING W/TOT ARM
84	AS-350801	3.5" Arch Swing Frame 8ft-1 Bay
84	AS-350802	3.5" Arch Swing Frame 8ft-2 Bay
84	AS-350803	3.5" Arch Swing Frame 8ft-3 Bay
84	AS-350804	3.5" Arch Swing Frame 8ft-4 Bay
84	SPS-0801	5" Single Post Swing 8ft-1 Bay
84	SPS-0802	5" Single Post Swing 8ft-2 Bay
84	SPS-0803	5" Single Post Swing 8ft-3 Bay
84	SPS-0804	5" Single Post Swing 8ft-4 Bay
84	SPS-0801-1A	5" Single Post Swing 8ft 1 - Bay W/ARM
84	SPS-0801-TS	5" Single Post Swing Bucket Tree Swing
84	SS-0011	Full Bucket Seat & Galvanized Steel Chain Set
84	SS-0012	Belt Seat & Galvanized Steel Chain Set
85	QSQB-210001N	QUBEST
85	QSQB-210001P	QUBEST
85	QSQB-21097N	Q
85	QSQB-21097P	Q
85	QSQB-210002N	SKQUBE
85	QSQB-210002P	SKQUBE
85	QSQB-210004N	RUBY QUBE
85	QSQB-210004P	RUBY QUBE
86	QSFS-SL72031LSN	6' FREESTANDING SINGLE SLIDE
86	QSFS-SL72031LSP	6' FREESTANDING SINGLE SLIDE
86	QSFS-SL6001WCN	5' FREESTANDING SINGLE SLIDE
86	QSFS-SL6001WCP	5' FREESTANDING SINGLE SLIDE
86	QSMR-210002	DELICATE ARCH
86	QSMR-210001	BALANCED ROCK I
87	QSSR-21006	FIRE TRUCK RIDER
87	QSSR-21007	BEE RIDER
87	QSSR-21008	HORSE RIDER
87	QSSR-21004	PONY RIDER
88	QSHW1-S308	CATERPILLAR CRAWL TUNNEL-UNIT
88	QSHW1-S309	CATERPILLAR CRAWL TUNNEL-COMPLETE SET
89	QS75-21003	STAND & SPIN
89	QSL5-JSQC006	WISE TOSS
89	QS75-21004	LOTUS SPINNER
89	QS72-21032	PLAYGROUND BALLS (SET OF 6)
90	QS72-22001	GFRS TIMBER CRAWL TUNNEL
90	QSFS-CL0019N	FROG HOPPER
90	QS72-21031	TETHERBALL SET
90	QS75-21009-110	BALANCE BEAM
90	QS75-21012-111	LEAF BALANCE STEPS
91	QS78-21001	WISE BLACKBOARD
91	QS78-21002	WISE WHITE BOARD
91	QS78-21003	WISE PAINT BOARD
91	QS78-21007	ALLIE THE APPLE
91	QS78-21008	FIONA THE FLOWER
91	QS78-21006	CAREY THE CARRO
92	QSFS-WP0001N	ALTO
92	QS72-22004	BONGO DRUMS
92	QS72-22003	RAINBOW XYLOPHONE
92	QS72-22002	SPLIT RAINBOW XYLOPHONE
93	QSTB-5212-AP	12" TIMBER BORDER W/SPIKE
93	QSTB-6244-AP	HALF ADA RAMP
94	QSSAP-21001-110	6'RECTANGULAR PICNIC TABLE PERFORATED PATTERN
94	QSSAP-21002-110	6' BENCH W/BACKPERFORATED PATTERN
94	QS72-21021-114	WISEBIN
94	QS72-21022-110	WISEBIN WITH RAIN COVER
94	QS72-21015-131	SINGLE BIKE RAC
94	QS72-21016-131	DOUBLE BIKE RACK
98	TOT35CL-0001	SEQUOIA
99	TOT35CL-0009	LITTLE SNUFFY
99	TOT35CL-0013	DAFFOIL
100	TOT35CL-0005	TOADS PLAY
100	TOT35CL-0003	DAHLIA
101	TOT35CL-0002	IRIS
102	TOT35CL-0006	COSMOS
102	TOT35CL-0010	POLLYWOGS
103	TOT35CL-0004	MADELINE
104	TOT35CL-0011	GNOMES HUT
105	TOT35CL-0007	BEDELIA
105	TOT35CL-0014	MAISY
106	TOT35CL-0008	MARIGOLD
106	TOT35CL-0012	PETUNIA
108	PDWP-350090C13	TIPPY-TOE
109	PDWP-350097C11	ZOEY
110	PDWP-350098C12	SWEET MAY
110	PDWP-350099C11	LITTLE STAR
111	YJ001316-V01	FIRE ENGINE
112	YJ001317-V01	BEEP JEEP
112	YJ001319	AIRPLANE
116	PDWP-350071C00	EVOLUTION
117	PDWP-350072C33	WISE TRAVELER
118	PDWP-350075C33	ISLAND WONDER
119	PDWP-350073C00	CHARLOTTE'S FUN ZONE
120	PDWP-350074C33	WACKY WISE
121	PDWP-350036C32	ROUND ABOUT
122	PDWP-350070C32	TIMBERLAND
124	PDWP-350029C32	BALI
125	PDWP-350030C00	SUNDAZED
126	PDWP-350031C32	PINWHEEL PARADE
127	PDWP-350032C32	PARADISE
128	PDWP-350033C15	MCCALL
129	PDWP-350034C00	GOLDSTAR
130	PDWP-350035C00	FANTASTIC FUN
131	PDWP-350076C00	CLIMB AND RIDE

132	PDWP-350081C32	ANASTASIA
133	PDWP-350078C00	ARIEL
134	PDWP-350079C32	DARWINS
135	PDWP-350080C11	FINSTER
136	PDWP-350077C15	TWISTER
137	PDWP-350082C32	JUNGLEGEM
138	PDWP-350083C00	ROVER RIDER
138	PDWP-350084C00	WHIRLIEWORLD
139	PDWP-350085C32	BRISK SEABREEZE
140	PDWP-350086C13	DREAMLAND
141	PDWP-350087C00	AUTUMN
142	PDWP-350088C12	AVONDALE
143	PDWP-350089C13	TERRYS MAZE
144	PDWP-350091C32	LIGHTHOUSE
145	PDWP-350094C32	EBULLIENCE
146	PDWP-350092C00	AMBERLEY
147	PDWP-350093C00	RIALTO
148	PDWP-350093C32	SALMON
149	PDWP-350095C12	KUZKO
150	PDWP-350096C32	MOWGI
151	WPPE-350002C13	LILLY PAD
152	WPPE-350001C15	TREBLE LEAF
153	BS35CS-0001	WISE KINGDOM
155	BS35CS-0003	ARTHER
155	BS35CS-0007	ASLAN
155	BS35CS-0009	LOUIS
156	BS35CS-0006	CHAMELOT
156	BS35CS-0008	CHARLES
156	BS35CS-0010	RICHARD
157	BS35TH-0001	AMAZON FOREST
158	BS35TH-0002	MONTEVERDE
159	BS35TH-0003	BORNEO
159	BS35TH-0005	SINHARAJA
160	BS35TH-0004	KIPLING
160	BS35TH-000	DAINTREE
161	BS35PS-0001	MEDITERRANEAN
162	WPPE-350003C00	SHREVEPORT
163	BS35PS-000	SOUTHERN
164	BS35PS-0006	ARABIAN
168	AT50TH-0012	IMAGINATION ZONE
170	AT50TH-0001	TREE TOP PARADISE
171	AT50TH-0011	ALOHA
172	AT50TH-0003	ALL SEASON TREEHOUSE
173	AT50CS-0001	CASTLE PEAK
174	AT50CS-0003	WOODLANDS FORT
175	AT50CS-0002	BRIGHTWATER FORTRESS
176	AT50CS-0004	MOUNTAIN PALACE
177	AT50PS-0001	SCALAWAGS
178	AT50PS-0002	ATLANTIS SEAS
181	LS-JSQC004	HORIZONTAL PLAYGROUND NET
181	LS-JSQC003	WAVY PARALLEL BARS
181	63-21029-110113	UP & OVER CLIMBE
181	LS-JSQC005-112123	LEAP PADS
181	LS-JSQC001	LEAP CLIMBER
181	LS-JSQC002	NET & ROCK CLIMBER
181	63-21031-111	DOUBLE UP & OVER CLIMBER
182	QSFS-CL0020N	WISE DUAL LEVEL
182	79-23001	WISE BENCH
182	79-23003	WISE PUSH UP BARS
182	QSFS-CL0021N	WISE TRI - LEVEL BARS
182	79-23002	WISE BACK STRETCH
182	79-23004	WISE LIFT
182	79-23005	WISE STEP UP
184	PDFS-CL0024C	TRIFECTA CHALLENGE
185	PDFS-CL0011C	FUN WAYS
185	PDFS-CL0012C	WOBBLEY WA
186	PDFS-CL0031C	DOJO
187	PDFS-CL0030C	WILDER
187	PDFS-CL0028C	SPIDER CLIMBER
187	FS-CL0022N	SHIMMY
187	FS-CL0023N	TEATER TUNNEL
188	PDQB-210013C	DRAGONFLY
189	PDQB-210010C	VISIONARY
189	QB-210012P	QUBE CLIMB AND SLIDE
190	QB-210003	DOUBLE TROUBLE QUBE
190	QB-210009N	GRAVITRON
190	QB-210005	PROFESSORS QUBE
191	MR-210001C113122	BALANCED ROCK
191	MR-210002C113123	DELICATE ARCH
192	MR-210006N	PARK AVENUE
192	MR-210005P	DOUBLE ARCH
192	MR-210003C113130	THE WINDOWS
192	MR-210004C114122	LA SAL
193	WS-210001C116	HURRAH
194	WS-210002C114121	ARCHES
194	WS-210001C77121122	CANYON LANDS
194	WS-210001C11412012	BUGGY
194	WS-210001C113114118	SLICKROCK
195	HW1-S1A352	OUTDOOR MOTOR SKILLSTRAINREGULAR SET
195	HW1-S1A353	OUTDOOR MOTOR SKILLSTRAINCORNER SET
196	HW1-S1A359	Outdoor Motor Skills-TrainEngine
196	HW1-S1A354	Outdoor Motor Skills-TrainBridging Carriage
196	HW1-S1A355	Outdoor Motor Skills-TrainClimbing Carriage
196	HW1-S1A356	Outdoor Motor Skills-TrainEntrance Carriage
196	HW1-S1A357	Outdoor Motor Skills-TrainRope Maze Carriage
196	HW1-S1A358	Outdoor Motor Skills-TrainCrawl Tunnel

196	HW1-S1A358	Outdoor Motor Skills-TrainClimbing Bridge
196	HW1-S1A359	Outdoor Motor Skills-TrainNet Bridge
196	HW1-S1A360	Outdoor Motor Skills-TrainRopes Balance
196	HW1-S1A362	Outdoor Motor Skills-TrainLogs Balance
196	HW1-S1A361	Outdoor Motor Skills-TrainStumps Balance
196	HW1-S1A363	Outdoor Motor Skills-TrainStepping Leaves Balance Bar
196	HW1-S1A364	Outdoor Motor Skills-TrainMushroom Stones Balance Bar
197	FS-SL7200N	360 FREESTANDING SPIRAL SLIDE
197	FS-SL6000P	270 FREESTANDING SPIRAL SLIDE
197	FS-SL72033N	WIGGLY RACE
197	FS-SL4801N	4' FREESTANDING SINGLE SLIDE
197	FS-SL4802P	4' FREESTANDING DOUBLE SLIDE
198	SR-21005	DUO-SEESAW
198	SR-21012-113	QUAD-SEESAW
198	SR-21009	TRI-SEESAW
198	SR-21010	BOUNCE AND BALANCE
199	75-21020-110113	WEE TREE SWING
199	76AM-002	ROCK AND ROLL ON
199	HW1-S101	THROUGH THE JUNGLE-SINGLE
199	63-21078	GFRS STUMP JUMP
199	75-21032-110113	HANG AND SPIN
199	75-21014-114	TWIRL A WHIRL
199	75-21005	SPIN BOARD
200	FS-WP0002C	SENSORY STATION QUAD SET
200	PDFS-CL0010C	BRAIN GAMES
200	FS-WP0005C	SENSORY STATION PAIR
200	72-21017-111	TRIPLE BIKE RACK
200	SA-21007-110	WISE CUSTOMIZABLE BENCH
200	KB4-7204-110	46" ROUND TABLE 4 SEATS DIAMOND PATTERN
200	KB4-7205-110	ADA 46" ROUND TABLE 3 SEATS DIAMOND PATTERN
200	SA-21003-110	8FT RECTANGLE TABLE DIAMOND PATTERN
204	HW1-S291	HIKER'S HIDEOUT
205	HW1-S292	RUSTIC RIDGE
205	HW1-S293	ADVENTURE CAMP
205	HW1-S294	PEACEFUL PINES
206		